



HI98594
Portable
pH/EC/Turbidity/opdo[®] Meter
with Bluetooth[®] Technology

Dear Customer,

Thank you for choosing a Hanna Instruments® product.

Please read this instruction manual carefully before using this instrument as it provides the necessary information for correct use of this instrument, and a precise idea of its versatility.

If you need additional technical information, do not hesitate to e-mail us at tech@hannainst.com.

Visit www.hannainst.com for more information about Hanna Instruments and our products.

All rights are reserved. Reproduction in whole or in part is prohibited without the copyright owner's written consent, Hanna Instruments Inc., Woonsocket, Rhode Island, 02895, USA. Hanna Instruments reserves the right to modify the design, construction, or appearance of its products without advance notice.

TABLE OF CONTENTS

1. Preliminary Examination	4	9. Maintenance	47
2. Battery Safety	5	9.1. General Maintenance	47
3. General Description & Intended Use	6	9.2. Sensor Maintenance	48
4. Specifications	7	9.3. Sensor Replacement	48
4.1. System Specifications	7	9.4. Sensor Types & Descriptions	49
4.2. Probe Specifications	11	9.5. Sensor Installation	50
4.3. Sensor Specifications	11	10. System Setup	52
5. Functional & Keypad Description	14	10.1. Meter Setup	52
6. General Operations	16	10.2. Probe Setup	57
6.1. Battery Capacity, Replacement, Recharging	16	11. Bluetooth® 5.0	58
6.2. Connecting the Probe & Getting Started	17	11.1. Using Hanna Lab App	58
6.3. Turning the Meter On	19	11.2. Pair a New Device	58
6.4. Tutorial	19	11.3. Delete Paired Devices	59
6.5. Basic Operations	20	11.4. Firmware Update	59
6.6. Help	20	12. Status	60
6.7. Functional Diagram of the Instrument	21	12.1. Meter Status	60
7. Parameter Setup	22	12.2. Probe Status	60
7.1. Parameter Selection	23	12.3. GLP	61
7.2. Parameter Units	23	13. Measurement	63
7.3. Parameter Coefficients	26	14. Logging	64
7.4. Averaging	27	14.1. One Sample on Meter	64
7.5. Turbidity Averaging	27	14.2. Start Meter Log	65
8. Calibration	28	14.3. Log Recall	66
8.1. Quick Calibration	29	14.4. Log Notes	69
8.2. pH Calibration	31	14.5. PC Connection	69
8.3. ORP Calibration	34	15. Troubleshooting & Error Messages	70
8.4. Dissolved Oxygen Calibration	35	16. Accessories	72
8.5. Conductivity Calibration	39	Certification	75
8.6. Turbidity Calibration	43	Recommendations for Users	75
8.7. Temperature Calibration	45	Warranty	75
8.8. Pressure Calibration	46	Regulatory Notices	76

1. PRELIMINARY EXAMINATION

Remove the instrument and accessories from the packaging and examine it carefully.

For further assistance, please contact your local Hanna Instruments® office or email us at tech@hannainst.com.

Each [HI98594](#) is delivered in a rugged carrying case and is supplied with:

- [HI7698594](#) Multisensor probe
- [HI7698194-1](#) pH/ORP sensor (pre-installed on the probe)
- [HI7698594-4](#) EC/Turbidity sensor (pre-installed on the probe)
- [HI7698594-5](#) Optical DO sensor (pre-installed on the probe)
- [HI764113-1](#) DO Smart Cap with o-ring
- [HI7698296](#) Long protective probe shield
- [HI7698293](#) Long calibration beaker
- [HI9828-20](#) Quick calibration standard solution (230 mL)
- [HI7040](#) Zero oxygen solution set (120 mL)
- [HI9829-16](#) 0 FNU calibration solution (230 mL)
- [HI9829-17](#) 20 FNU calibration solution (230 mL)
- [HI9829-18](#) 200 FNU calibration solution (230 mL)
- [HI76984942](#) Probe maintenance kit (accessories box included)
- [HI710036](#) Protective rubber boot (fitted on the meter)
- [HI920016](#) USB cable
- 1.5V AA alkaline batteries (4 pcs.)
- Quick reference with QR code for manual download
- Instrument quality certificate
- Probe quality certificate
- DO Smart Cap quality certificate

Note: Save all packing material until you are sure that the instrument works correctly. Any damaged or defective item must be returned in its original packing material with the supplied accessories.

2. BATTERY SAFETY

The coin-cell battery is replaceable by a professional service center only.

WARNING

- **INGESTION HAZARD:** This product contains a button cell or coin battery.
- **DEATH** or serious injury can occur if digested.
- A swallowed button cell or coin battery can cause **Internal Chemical Burns** in as little as **2 hours**.
- **KEEP** new and used batteries **OUT OF REACH OF CHILDREN**.
- **Seek immediate medical attention** if a battery is suspected to be swallowed or inserted inside any part of the body.



- Remove and immediately recycle or dispose of used batteries according to local regulations and keep away from children.
Do NOT dispose of batteries in household trash or incinerate.
- Even used batteries may cause severe injury or death.
- Call a local poison control center for treatment information.
- Coin-cell battery type CR2032
- Nominal voltage 3.0 V
- Non-rechargeable batteries are not to be recharged.
- Do not force discharge, recharge, disassemble, heat above 85 °C (185 °F) or incinerate. Doing so may result in injury due to venting, leakage or explosion resulting in chemical burns.
- Ensure the batteries are installed correctly according to polarity (+ and -).
- Do not mix old and new batteries, different brands or types of batteries, such as alkaline, carbon-zinc, or rechargeable batteries.
- Remove and immediately recycle or dispose of batteries from equipment not used for an extended period of time according to local regulations.
- Always completely secure the battery compartment. If the battery compartment does not close securely, stop using the product, remove the batteries, and keep them away from children.

3. GENERAL DESCRIPTION & INTENDED USE

HI98594 is a portable logging multiparameter system (meter and probe) that monitors up to 14 different water quality parameters (7 measured and 7 calculated) such as pH, ORP, conductivity, turbidity, pressure, dissolved oxygen and temperature. Each parameter is fully configurable.

The HI98594 features a graphic, backlit display that automatically sizes the digits to fit the screen with on-screen graphing capability.

The HI7698594 multisensor probe uses:

- HI7698194-1 sensor for pH and ORP measurements
- HI7698594-4 sensor for turbidity and conductivity (with associated parameters) measurements
- HI7698594-5 optical DO sensor with HI764113-1 DO Smart Cap for dissolved oxygen measurements

The probe also has an internal temperature sensor and a removable protective shield.

The HI98594 system is easy to setup and use.

It has a built-in tutorial mode to guide users step-by-step through sensor preparation, installation, maintenance, and calibration processes.

The meter utilizes a dual charging system, utilizing a rechargeable Li-ion battery and backup alkaline batteries to extend field use.

The meter can log data that can be easily downloaded as a .CSV file or graph using Bluetooth® wireless technology to Hanna Lab on iOS and Android devices or to a type-C, USB flash drive.

The HI98594 meter was designed to withstand harsh environmental conditions and is ideal for field measurements. The meter comes with a protective rubber boot and meets IP67 standard (30 minutes immersion at 1 m depth). The multisensor probe is totally sealed against water and dust, and meets IP68 standard (continuous immersion in water).

Main Features

- Rugged, water-resistant meter and waterproof probe
- Monitors up to 14 different water quality parameters
- Instantaneous conductivity and turbidity measurements
- Field-replaceable sensors with auto recognition (including optical DO technology)
- Built-in barometer for percent saturation and DO concentration compensation
- Dual battery system for extended field use
- Good Laboratory Practice feature, the last 5 calibrations are automatically stored
- Graphical display of logged data on backlit LCD screen
- Log-on-demand and automatic logging on meter for all parameters
- Download log files
 - » to Hanna Lab using Bluetooth wireless technology
 - » to a type-C, USB flash drive
- USB-C interface for PC communication
- Remote firmware update

4. SPECIFICATIONS

4.1. SYSTEM SPECIFICATIONS

pH/mV

Range	0.00 to 13.00 pH ± 600.0 mV
Resolution	0.01 pH 0.1 mV
Accuracy*	± 0.05 pH ± 3.0 mV
Calibration	<ul style="list-style-type: none"> One point using HI9828-20 Quick calibration solution Up to three points using pH 4.01, pH 6.86, pH 7.01, pH 9.18, pH 10.01 standard buffers and one custom buffer

ORP

Range	± 2000.0 mV
Resolution	0.1 mV
Accuracy*	± 10.0 mV
Calibration	Automatic at one custom point (relative mV)

Dissolved Oxygen (DO)

Range	0.0 to 500.0 % saturation 0.00 to 50.00 ppm (mg/L)
Resolution	0.1 % saturation 0.01 ppm (mg/L)
Accuracy*	<ul style="list-style-type: none"> ± 1.5 % of reading from 0.0 to 200.0 % saturation ± 5 % of reading from 200.0 to 500.0 % saturation ± 1.5 % of reading from 0.00 to 20.00 mg/L ± 5 % of reading from 20.00 to 50.00 mg/L
Calibration	<ul style="list-style-type: none"> One point, quick calibration in water-saturated air One or two points, at 100 % and 0 % One point, using a custom solution (% saturation or mg/L)
Pressure compensation	Automatic 450 to 850 mmHg

* Accuracy is evaluated with a calibrated system at ambient temperature.

Conductivity

Range	0 to 200 mS/cm 0 to 400 mS/cm (absolute)
Resolution	<ul style="list-style-type: none"> • Manual 1 μS/cm 0.001 mS/cm; 0.01 mS/cm; 0.1 mS/cm; 1 mS/cm • Automatic 1 μS/cm from 0 to 9999 μS/cm 0.01 mS/cm from 10.00 to 99.99 mS/cm 0.1 mS/cm from 100.0 to 400.0 mS/cm • Automatic (mS/cm) 0.001 mS/cm from 0.000 to 9.999 mS/cm 0.01 mS/cm from 10.00 to 99.99 mS/cm 0.1 mS/cm from 100.0 to 400.0 mS/cm
Accuracy*	± 1 % of reading or ± 1 μ S/cm, whichever is greater
Calibration	<ul style="list-style-type: none"> • One point using HI9828-20 Quick calibration solution • One point using 84 μS/cm, 1413 μS/cm, 5.00 mS/cm, 12.88 mS/cm, 80.0 mS/cm, 111.8 mS/cm standard solutions or custom point

Resistivity

Range	0 to 999999 Ω -cm 0 to 1000.0 k Ω -cm 0 to 1.0000 M Ω -cm	depending on resistivity reading
Resolution	1 Ω -cm 0.1 k Ω -cm 0.0001 M Ω -cm	
Calibration	Based on conductivity calibration	

Total Dissolved Solids (TDS)

Range	0 to 400000 ppm (mg/L) (the maximum value depends on the TDS factor)
Resolution	<ul style="list-style-type: none"> • Manual 1 ppm (mg/L) 0.001 ppt (g/L); 0.01 ppt (g/L); 0.1 ppt (g/L); 1 ppt (g/L) • Automatic 1 ppm (mg/L) from 0 to 9999 ppm (mg/L) 0.01 ppt (g/L) from 10.00 to 99.99 ppt (g/L) 0.1 ppt (g/L) from 100.0 to 400.0 ppt (g/L) • Automatic: ppt (g/L) 0.001 ppt (g/L) from 0.000 to 9.999 ppt (g/L) 0.01 ppt (g/L) from 10.00 to 99.99 ppt (g/L) 0.1 ppt (g/L) from 100.0 to 400.0 ppt (g/L)
Accuracy	± 1 % of reading or ± 1 ppm (mg/L), whichever is greater
Calibration	Based on conductivity or salinity calibration

* Accuracy is evaluated with a calibrated system at ambient temperature.

Salinity

Range	0.00 to 70.00 PSU
Resolution	0.01 PSU
Accuracy	$\pm 2\%$ of reading or ± 0.01 PSU, whichever is greater
Calibration	One point, using a custom solution

Seawater Sigma

Range	0.0 to 50.0 σ_t , σ_θ , σ_{15}
Resolution	0.1 σ_t , σ_θ , σ_{15}
Accuracy	± 1.0 σ_t , σ_θ , σ_{15}
Calibration	Based on conductivity or salinity calibration

Turbidity

Range	0.0 to 99.9 FNU 100 to 1000 FNU
Resolution	0.1 FNU from 0.0 to 99.9 FNU 1 FNU from 100 to 1000 FNU
Accuracy*	± 0.3 FNU or $\pm 2\%$ of reading, whichever is greater
Calibration	Automatic Up to three points using 0 FNU, 20 FNU, 200 FNU, or custom

Atmospheric Pressure

Range	450.0 to 850.0 mmHg	8.702 to 16.436 psi
	17.72 to 33.46 inHg	0.5921 to 1.1184 atm
	600.0 to 1133.2 mbar	60.00 to 113.32 kPa
Resolution	0.1 mmHg	0.001 psi
	0.01 inHg	0.0001 atm
	0.1 mbar	0.01 kPa
Accuracy	± 3.0 mmHg within ± 15 °C from calibration temperature	
Calibration	Automatic at one custom point	

* Accuracy is evaluated with a calibrated system at ambient temperature.

Temperature

Range	-5.00 to 50.00 °C 23.00 to 122.00 °F 268.15 to 323.15 K
Resolution	0.01 °C 0.01 °F 0.01 K
Accuracy	±0.15 °C ±0.27 °F ±0.15 K
Calibration	Automatic at one custom point

Other Specifications

Temperature compensation	Automatic	-5 to 50°C 23 to 122 °F 268.15 to 323.15 K
Logging memory	<ul style="list-style-type: none"> Interval logging 50000 records Log-on-demand (all parameters) 20000 records 	
Logging interval	1 second to 3 hours	
USB-C (host) functions	Mass-storage host	
USB-C (device) functions	Mass-storage device	
Protection rating	IP67	
Environment	0 to 50 °C (32 to 122 °F); RH 100 %	
Battery type	4 × 1.5 V AA alkaline batteries 1 × internal, Li-ion rechargeable battery	
Battery life	≈ 126 hours 90 hours using alkaline AA batteries 36 hours using Li-ion battery*	
Dimensions	185 × 93 × 35.2 mm (7.3 × 3.6 × 1.4")	
Weight (with batteries)	435 g (13.3 oz)	

*Estimated time given without backlight and Bluetooth®

4.2. PROBE SPECIFICATIONS

Sensor inputs	pH or pH/ORP EC/Turbidity Dissolved Oxygen	
Sample environment	Fresh, brackish, seawater	
Protection rating	IP68	
Operating temperature	-5.0 to 50.0 °C 23.0 to 122.0 °F	
Storage temperature	-20.0 to 70.0 °C -4.0 to 158.0 °F	
Immersion depth	20 m (66')	
Dimensions (without cable)	Length	342 mm (13.5")
	Diameter	46 mm (1.8")
Weight (with sensors)	570 g (20.1 oz.)	
Cable specification	Multistrand-multiconductor shielded cable with internal strength member rated for 90 kg (200 lbs) intermittent use	
Wetted materials	Body	ABS
	Threads	Nylon
	Shield	ABS and 316 stainless steel
	Temperature probe	316 stainless steel
	O-rings	EPDM (ethylene propylene diene monomer rubber)

4.3. SENSOR SPECIFICATIONS

HI7698194-0 pH	Measurement unit	pH mV (pH)		
	Measure range	0.00 to 12.00 pH ± 600.0 mV (pH)		
	Color code	Red		
	Operational temperature	-5.0 to 50.0 °C 23.0 to 122.0 °F		
	Materials	Tip	Glass	
		Junction	Wick	
		Body	PEI	
		Electrolyte	Gel	
	Maintenance solution	HI70300 Storage solution		
	Reference	Double junction		
Immersion depth	20 m (66')			
Dimensions	Length	118 mm (4.6")		
	Diameter	15 mm (0.6")		

HI7698194-1 pH/ORP	Measurement unit	pH mV (pH) mV (ORP)
	Measure range	0.00 to 12.00 pH ± 600.0 mV (pH) ± 2000.0 mV (ORP)
	Color code	Red
	Operational temperature	-5.0 to 50.0 °C 23.0 to 122.0 °F
	Materials	Tip Glass (pH) and ORP (platinum) Junction Wick Body PEI Electrolyte Gel
	Maintenance solution	HI70300 Storage solution
	Reference	Double junction
	Immersion depth	20 m (66')
	Dimensions	Length 118 mm (4.6") Diameter 15 mm (0.6")
HI7698594-4 EC	Measurement unit	μS/cm, mS/cm
	Measure range	0 to 200.0 mS/cm 0.0 to 400 mS/cm (absolute)
	Color code	Blue
	Operational temperature	-5.0 to 50.0 °C 23.0 to 122.0 °F
	Materials	Electrodes Stainless steel (AISI 316) Body ABS and Epoxy
	Immersion depth	20 m (66')
HI7698594-4 Turbidity	Measurement unit	FNU
	Measure range	0.0 to 1000 FNU
	Color code	Blue
	Operational temperature	-5.0 to 50.0 °C 23.0 to 122.0 °F
	Materials	Electrodes Stainless steel (AISI 316) Body ABS and Epoxy
	Immersion depth	20 m (66')
	Dimensions	135 × 35 mm

HI7698594-5 Dissolved Oxygen	Measurement unit	% saturation mg/L	
	Measure range	0.0 to 500.0 % saturation 0.00 to 50.00 mg/L	
	Color code	Green	
	Operational temperature	-5.0 to 50.0 °C 23.0 to 122.0 °F	
	Sensor type	Optical	
	Immersion depth	20 m (66')	
	Dimensions	Length	99 mm (3.9")
		Diameter	17 mm (0.7")

5. FUNCTIONAL & KEYPAD DESCRIPTION

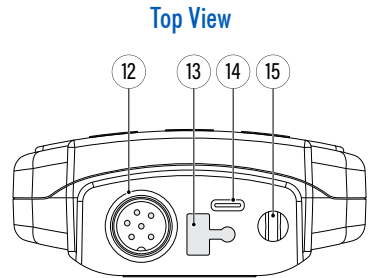
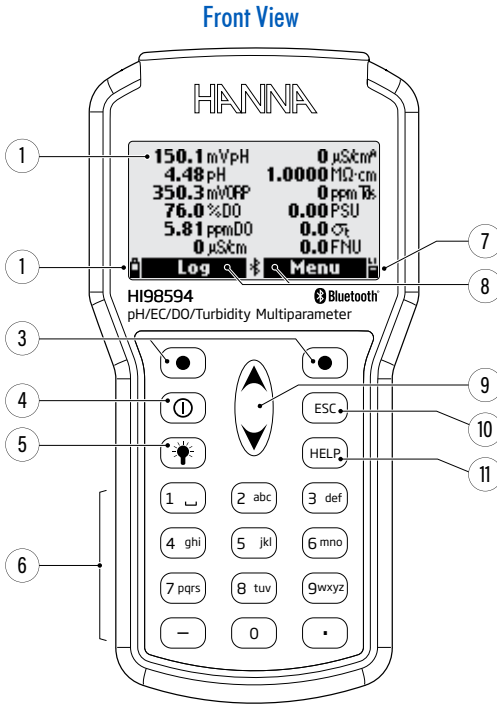

1. Liquid Crystal Display (LCD)
2. Alkaline battery level indicator
3. Functional keys
Press to perform the function displayed on the screen.
4. Power (On/Off) key
Press to turn the meter on or off.
5. Lamp key
Press to turn the backlight on or off.
6. Alphanumeric keypad
Press to insert alphanumeric codes.
7. Rechargeable battery level indicator
8. Soft key functions defined on display
9. Arrow keys, scroll the displayed options and messages
10. ESC key
Press to return to the previous screen.
11. HELP key
Press to display the context sensitive help menu.

12. Probe connector
13. USB-C protective cap
14. USB-C connector
15. Strap hook

HI7698594 Multisensor Probe

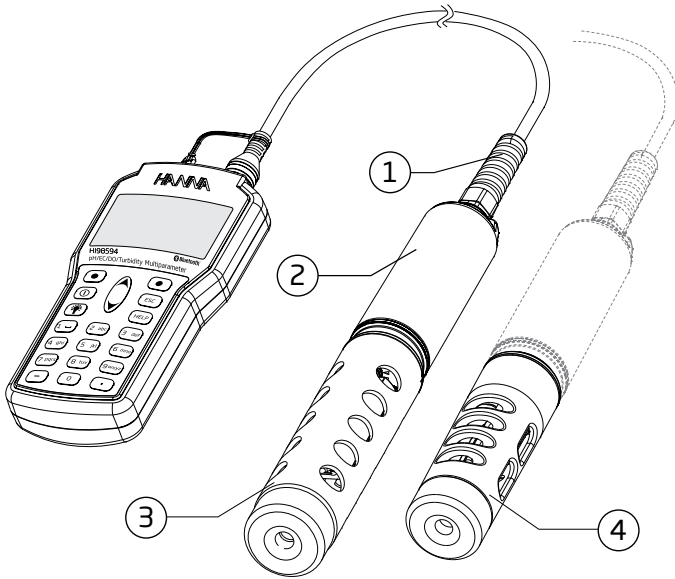

1. Strain relief
2. Sensor body
3. Long protective shield > [HI7698296](#)
4. Short protective shield > [HI7698295](#)
Cover option when EC/Turbidity sensor is not used. Ordered separately.

6. GENERAL OPERATIONS

6.1. BATTERY CAPACITY, REPLACEMENT, RECHARGING

HI98594 is equipped with a primary, internal Li-ion battery and supplied with 4 alkaline, 1.5 V AA batteries. When the primary, rechargeable battery is completely discharged (0%), the meter will switch to the backup, alkaline batteries.

The battery level indicators on the LCD indicate the battery life.

If the battery capacity is less than 10% both indicators are displayed blinking. The primary battery should be recharged and the alkaline ones replaced.

The instrument is equipped with the BEPS (Battery Error Prevention System) feature, which automatically turns the instrument off when primary and alkaline batteries reach 0%.

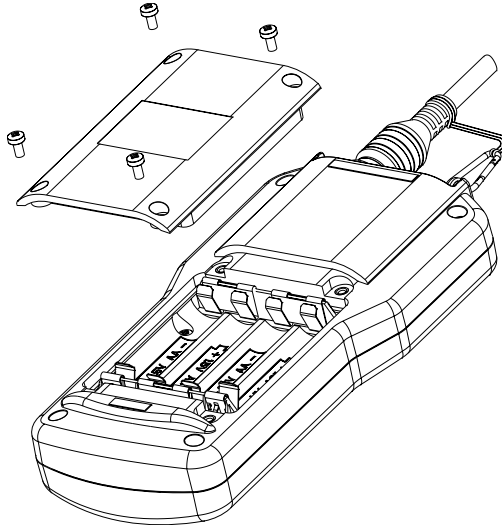

Replacing the **alkaline batteries**

1. Turn off the instrument.
2. Remove the four screws on the back of the instrument to open the battery compartment.
3. Remove the old batteries.
4. Insert four new 1.5V AA batteries in the battery compartment while paying attention to the correct polarity.
Do not mix old and new alkaline batteries.
5. Close the battery compartment using the four screws.

Note: If the battery capacity is less than 25%, the backlight is no longer available.

Recharging the Li-ion battery

Plug the USB cable (supplied) into the USB-C port on top of the instrument and into a USB-C power adapter or a laptop/PC port.

Battery charging animated icon is displayed during recharge (bottom right corner of the screen), the battery level (as a percentage of fully charged), and the battery charging status (On or Off) are also displayed.

With the meter turned off and connected to power, a battery charging animated icon informs the user of the in-progress operation.

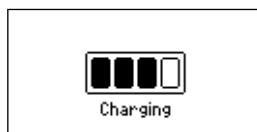
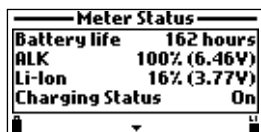

6.1.1. Battery Life

The battery life is dependent on the backlight usage, logging interval, and sensor configuration. The backlight will consume the most power.

Backlight	Logging Interval	Sensor Configuration	Battery Life
Off	1 second	pH/ORP, DO, EC/Turbidity	200 hours
Off	4 minutes	pH/ORP, DO, EC/Turbidity	260 hours
On	4 minutes	pH/ORP, DO, EC/Turbidity	50 minutes
Off	10 minutes	pH/ORP, DO, EC/Turbidity	270 hours
On	10 minutes	pH/ORP, DO, EC/Turbidity	50 minutes

6.2. CONNECTING THE PROBE & GETTING STARTED

The multiparameter probe is connected to the meter through a waterproof quick connector.

When connected, the probe is automatically detected.

- With the meter off, connect the probe to the connector on the top of the meter.
- Align the pins and key then push the plug into the socket.
- Wrap attached strap around probe cable and thread through the looped end.

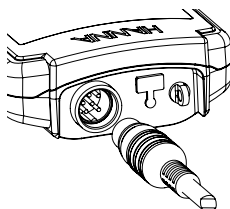

Before taking measurements, there are three steps that must be completed:

1. Probe and sensor preparation (See section [6.2.1. Probe and Sensor Preparation](#))
2. Hydration (See section [6.2.2. Hydration](#))
3. Calibration (See section [8. Calibration](#))

6.2.1. Probe and Sensor Preparation

Remove the protective shield from the probe and set aside.

DO Smart Cap hydration

Hydrate the [HI764113-1](#) Smart Cap following the instructions below.

- a. Remove the optical cap from the cap kit.
- b. Place the cap in a container with purified water. There should be just enough liquid for the cap end to be submerged in the water.
- c. Allow the Smart Cap to soak in purified water for a minimum of 8 hours to hydrate for optimal calibration. The cap is now ready for installation.

DO Smart Cap installation

Install the [HI764113-1](#) Smart Cap on the [HI7698594-5](#) DO sensor following the instructions below.

Note that it may be easier to remove the DO sensor from the probe.

- a. Remove the shipping cap from the DO sensor.
- b. Remove the syringe plunger.
- c. Cut the top off supplied sachet with silicone grease and empty contents into the syringe.
- d. Using the syringe, sparingly lubricate the o ring with a thin film of the supplied grease.
- e. Avoid getting grease or fingerprints onto the optical window.
- f. Do not substitute other grease or lubricants as it may cause the o ring to swell.
- g. Remove the hydrated cap from storage.
Ensure the inside of the cap does not have water prior to installation!
- h. Align the cutout arrow on the Smart Cap with the matching guide on the sensor body.
- i. Slide and press the Smart Cap onto the sensor body until the cap snaps in place.
Once the cap is installed, it should not be removed unless a new cap is required.

Note: *Using care, reinstall the sensor if it had been removed.*

6.2.2. Hydration

1. Remove the shipping cap from the pH/ORP sensor.
2. Place the probe with sensors under a stream of water to rinse salt crystals from sensors.
3. Fill calibration beaker partially full of tap water.
Do not use deionized or distilled water.
4. Screw calibration beaker onto the probe.
5. Support probe in vertical position.
6. Allow the sensors to soak in water for a minimum of 30 minutes (or longer) before attempting calibration.

See section [8. Calibration](#) for more detailed descriptions of each sensor's calibration.

6.2.3. Calibration

Sensors must be calibrated before taking measurements.

1. Power meter then press **ESC** followed by **Menu**.
2. Select **Calibration**.
3. Use the on board Tutorial and/or Help button to pilot you through the calibration procedures.

Alternatively, go to section [8. Calibration](#) of this manual for more detailed directions.

6.3. TURNING THE METER ON

- Verify the sensors have been installed in the probe.
- Verify the probe has been connected to the meter.
- Press the On/Off key to turn the meter on.

At start-up the display will show the Hanna Instruments® logo, meter name, and firmware version.



After the initialization has been completed, if the probe is connected, the meter displays the Probe Status or the Tutorial Mode message.

The Probe Status screen identifies the probe and attached sensors.

See section [6.4. Tutorial](#) for information on the Tutorial mode.

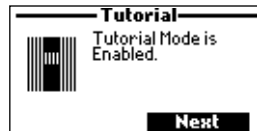

- Press **Measure** to view the measurement screen.
- Press **Param.** to open the Parameters menu.
This screen can also be accessed from the main menu.
- Press the down arrow key to view additional information about the probe.

6.4. TUTORIAL

If the tutorial is enabled, after the initialization has been completed, the Tutorial screen is displayed.

- Press **ESC** to view the Probe Status screen and skip the tutorial.
- Press **Next** to start the tutorial.

The following tutorials are available: Sensor Preparation, Sensor Maintenance, Sensor Installation.



- Press **Select** to view the selected tutorial.

6.5. BASIC OPERATIONS

The main operating modes are setup, measurement, and logging.

The instrument can be configured to display measurement data for all enabled parameters.

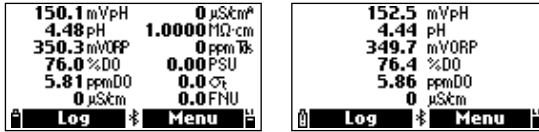

- Press the arrow keys to scroll between measured data in all available parameters. The display has a feature that automatically sizes the digits to fit the screen. With one measurement the digits will be largest.

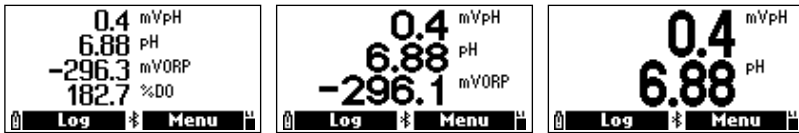

- Press the keys on the alphanumeric keypad (1 - 7) to select number of parameters displayed at one time.

Note: Pressing 7 will display up to 12 parameters simultaneously. Press down arrow to display any remaining parameters.

- Press **Measure** for **Log** and **Menu** functional keys to be displayed.
- Press **Log** to view the Log menu. Users can log a single measurement of the selected parameter or start an interval log. See section [14. Logging](#) for detailed description.
- Press **Menu** to select the measurement parameters. See section [7. Parameter Setup](#) for details.
- To calibrate the sensors » see section [8. Calibration](#).
- To change system settings » see section [10. System Setup](#).
- To enable or disable Bluetooth® and view the meter and probe status, see section [12. Status](#).

6.6. HELP

- Press the **HELP** key to view the context sensitive help.
- Use the arrow keys to scroll through the text.
- Press the **HELP** or **ESC** key to return to the previous screen.

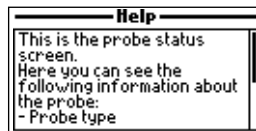

6.7. FUNCTIONAL DIAGRAM OF THE INSTRUMENT

Menu and **Log** functional keys help user navigate through all measurement operations. The following diagrams present an overview of possible functions.

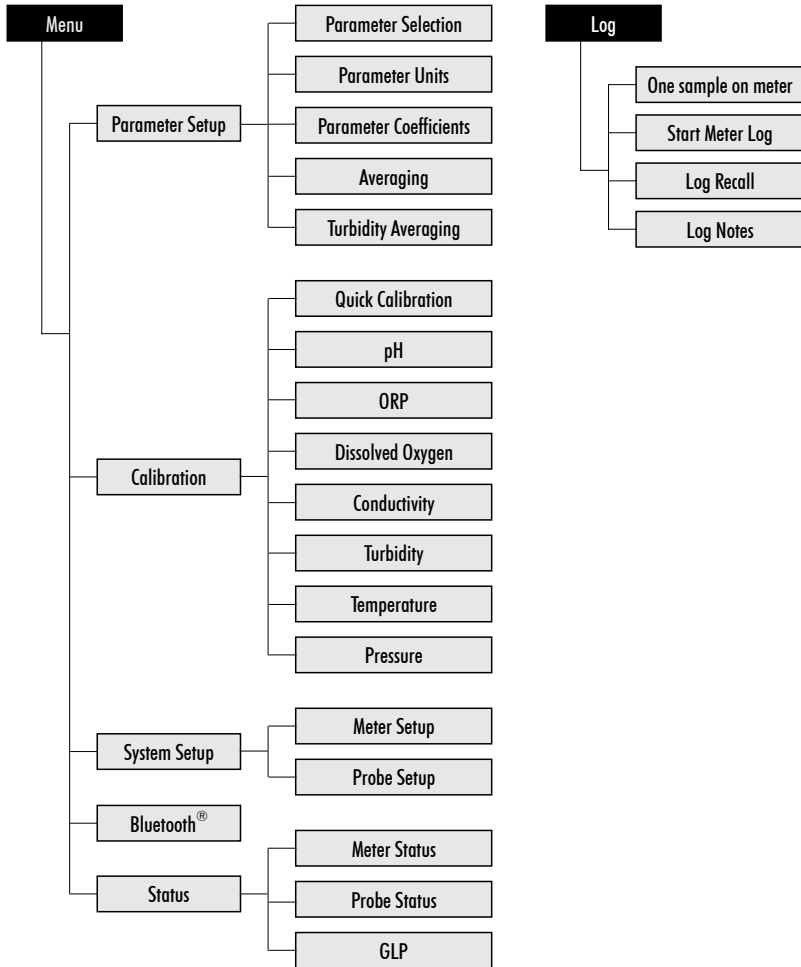

7. PARAMETER SETUP

- Press **Menu** from the measurement screen.
- Use the arrow keys to highlight “Parameter Setup” then press **Select**.
- Use the arrow keys to highlight the desired option then press **Select**.

Note: Data saved on the meter will be changed to selected parameter units or coefficients.



Parameter options and default settings

	Parameter Setup Items	Options / Range	Default
Parameter Selection	mV pH	Disable or Enable	Disable
	pH	Disable or Enable	Disable
	ORP	Disable or Enable	Disable
	% DO saturation	Disable or Enable	Disable
	DO concentration	Disable or Enable	Disable
	Conductivity	Disable or Enable	Disable
	Absolute conductivity	Disable or Enable	Disable
	Resistivity	Disable or Enable	Disable
	TDS	Disable or Enable	Disable
	Salinity	Disable or Enable	Disable
	Seawater	Disable or Enable	Disable
	Turbidity	Disable or Enable	Disable
	Temperature	Disable or Enable	Disable
	Pressure	Disable or Enable	Disable
Parameter Units	Temperature	°C, °F, K	°C
	TDS unit	ppm-ppt, mg/L- g/L	ppm-ppt
	DO concentration unit	ppm DO, mg/L DO	ppm DO
	Pressure unit	psi, mmHg, inHg, mbar, atm, kPa	psi
	Resistivity unit	Ω -cm, k Ω -cm, M Ω -cm	M Ω -cm
	Seawater sigma (σ) unit	σ_t , σ_0 , σ_{15}	σ_t
	EC Res.	Auto, Auto mS/cm, 1 μ S/cm, 0.001 mS/cm, 0.01 mS/cm, 0.1 mS/cm, 1 mS/cm	Auto
	Abs. EC Res.	Auto, Auto mS/cm, 1 μ S/cm, 0.001 mS/cm, 0.01 mS/cm, 0.1 mS/cm, 1 mS/cm	Auto
	TDS resolution	Auto, Auto ppt, 1 ppm, 0.001 ppt, 0.01 ppt, 0.1 ppt, 1 ppt	Auto
	Coefficients	EC Ref. Temp.	25 °C, 20 °C
EC Temp. Coeff.		0.00 to 6.00 %/°C	1.90 %/°C
TDS Factor		0.00 to 1.00	0.50
Averaging	Averaging	1 to 20 sample(s)	1 sample
	Turbidity Averaging	1 to 20 sample(s)	1 sample

7.1. PARAMETER SELECTION

- Use the arrow keys to scroll through the list of available parameters.
- Press the corresponding functional key to enable or disable selected parameter.
A checked box indicates that the parameter is enabled.



Note: When the password protection is enabled, authentication will be required before any parameter modification.

7.2. PARAMETER UNITS

When selected parameters have a single measurement unit, the Parameter Units screen will not be displayed. If a parameter has been disabled the units will not be displayed.

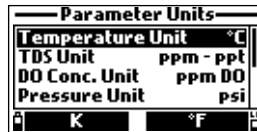

Temperature Unit

Option: °C, °F, K

Press the functional key to select the desired temperature unit.



TDS Unit

Option: ppm - ppt or mg/L - g/L

Press the functional key to select the desired TDS unit.

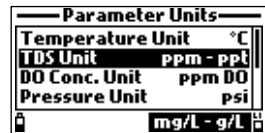

DO Concentration Unit

Option: ppm or mg/L

DO concentration is calculated using % saturation, pressure and temperature. Press the functional key to select the desired DO concentration unit.

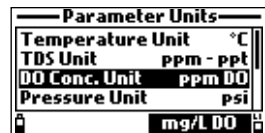

Pressure Unit

Option: psi, mmHg, inHg, mbar, atm, kPa

Press **Modify** and use the arrow keys to select the desired pressure unit.

Press **Select** to confirm or the **ESC** key to return to the previous screen.

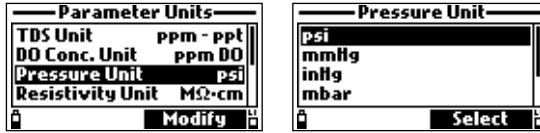

Resistivity Unit

Option: Ω -cm, k Ω -cm, M Ω -cm

Resistivity is calculated from the conductivity measurement.

Press the functional key to select the desired resistivity unit.



Seawater Sigma (σ) Unit

Option: σ_T , σ_0 , σ_{15}

Seawater sigma is calculated from the conductivity measurement and depends on water pressure, temperature, and salinity.

Press the functional key to select the desired reference temperature (current temperature, 0 °C, or 15 °C).

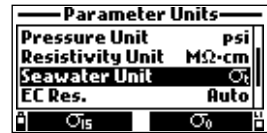

EC Resolution

Option: Auto, Auto mS/cm, 1 μ S/cm, 0.001 mS/cm, 0.01 mS/cm, 0.1 mS/cm, 1 mS/cm

- Press **Modify** and use the arrow keys to select the desired EC resolution.
- Press **Select** to confirm or the **ESC** key to return to the previous screen.

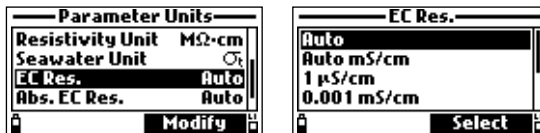

Auto The meter automatically chooses the range (μ S/cm or mS/cm) to optimize the measurement.

Auto mS/cm The meter automatically chooses the resolution to optimize the measurement. Readings are displayed in mS/cm only. Logged data retains auto units.

Specified numeric resolution The meter will not autorange. The measurement will be displayed with the selected measuring unit and decimals.

Absolute EC Resolution

Option: Auto, Auto mS/cm, 1 μ S/cm, 0.001 mS/cm, 0.01 mS/cm, 0.1 mS/cm, 1 mS/cm

- Press **Modify** and use the arrow keys to select the desired absolute EC resolution.
- Press **Select** to confirm or the ESC key to return to the previous screen.

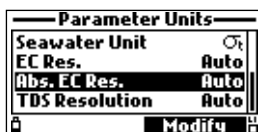

Auto The meter automatically chooses the range (μ S/cm or mS/cm) to optimize the measurement.

Auto mS/cm The meter automatically chooses the resolution to optimize the measurement. Readings are displayed in mS/cm only. Logged data retains auto units.

Specified numeric resolution The meter will not autorange.
The measurement will be displayed with selected measuring unit and decimals.

Note: A small letter "A" added to the μ S/cm or mS/cm unit refers to an absolute conductivity value.

TDS Resolution

Option: Auto, Auto ppt, 1 ppm, 0.001 ppt, 0.01 ppt, 0.1 ppt, 1 ppt

- Press **Modify** and use the arrow keys to select the desired TDS resolution.
- Press **Select** to confirm or the ESC key to return to the previous screen.

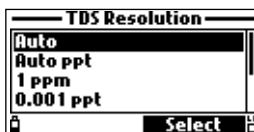
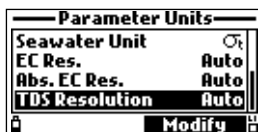

Auto The meter automatically chooses the range (ppm or ppt) to optimize the measurement.

Auto ppt The meter automatically chooses the resolution to optimize the measurement. Readings will be in ppt only.

Specified numeric resolution The meter will not autorange.
The measurement will be displayed with selected measuring unit and decimals.

7.3. PARAMETER COEFFICIENTS

EC Reference Temperature

Option: 20 °C or 25 °C

This value is used for temperature compensated conductivity.

All EC measurements will be referenced to the conductivity of a sample at this temperature.

Press the functional key to select the desired EC reference temperature.

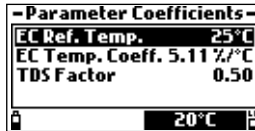

EC Temperature Coefficient (Beta, β)

Option: 0.00 to 6.00 %/°C

β is a function of the solution being measured.

For freshwater samples β is approximately 1.90 %/°C.

If the actual temperature coefficient of the sample is known, press **Modify** to enter the value.

Press **Accept** to confirm the value or the ESC key to return to the previous screen.

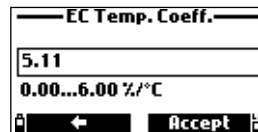

TDS Factor

Option: 0.00 to 1.00

TDS is a calculated value based on the conductivity of the solution ($TDS = \text{factor} \times EC_{25}$).

A typical TDS factor for strong ionic solutions is 0.50, while for weak ionic solutions is 0.70 (e.g. fertilizers).

Press **Modify** to enter the value.

Press **Accept** to confirm the value or the ESC key to return to the previous screen.

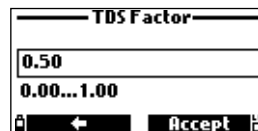

7.4. AVERAGING

Option: 1 to 20 samples

Averaging is a software filter to minimize measurement noise and provide more stable readings. It is particularly useful to get a representative reading of the “average” value from flowing water. Averaging will affect all measurements.

Note: If a fast response is needed, this value should be kept low.

- Press **Modify** to select the number of samples to average.
- Press **Accept** to confirm the value or the **ESC** key to return to the previous screen.

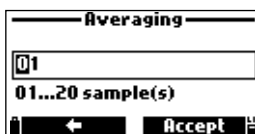

Note: When logging the first sample using averaging, it will be delayed by a few seconds.

7.5. TURBIDITY AVERAGING

Option: 1 to 20 samples

Turbidity averaging is software filter to minimize noise and provide more stable turbidity readings. It is particularly useful to get a representative reading of the “average” value from flowing water. Turbidity averaging will not affect other measurements and can be configured separately because the optical turbidity sensor is more strongly affected by bubbles and debris in the water stream than the other sensors.

- Press **Modify** to select the number of samples to average.
- Press **Accept** to confirm the value or the **ESC** key to return to the previous screen.

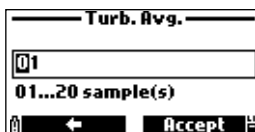

8. CALIBRATION

- Press **Menu** from measurement screen.
- Use the arrow keys to highlight **Calibration** then press **Select**.
- Use the arrow keys to highlight the desired option then press **Select**.



All calibration data is stored in the non volatile probe memory, allowing probes to be connected to different meters without recalibration.

Calibration options

Quick calibration A single point pH, conductivity, and/or dissolved oxygen calibration

Single parameter calibration Allows each parameter to be calibrated individually.

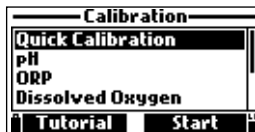

Note: The password will be required if password protection is enabled.

Calibration Guidelines

- Set up a routine service schedule where measurement integrity is validated.
- Do not handle the sensing surfaces of the sensors.
- Avoid rough handling and abrasive environments that can scratch the reactive surfaces of the sensors.
- Avoid exposure of sensors to bright sunlight. If possible, calibrate indoors.
- Discard standards after use.
Do not return the used standards to the bottles of "fresh" solution.
- For measurements across a temperature gradient (when water temperature is drastically different from the standards), allow the sensors to reach thermal equilibrium before conducting calibrations or making measurements.

Note: The heat capacity of the probe is much greater than the air and the small beakers of calibration standards.

- During calibration the temperature probe should also be in the calibration solution.

8.1. QUICK CALIBRATION

The quick calibration provides a single point calibration for pH, EC, and DO. Users can select to calibrate all sensors or any sensor combination.

Press **Skip** to escape a sensor calibration and move to next in series.

Note: If the tutorial mode is enabled, press Tutorial and follow the messages on the screen.

1. Remove the shield from the probe and rinse the probe with purified water.
2. Fill the calibration beaker $\frac{2}{3}$ full with **HI9828-0** calibration solution.
3. Immerse the sensors in the calibration solution. Raise and lower the probe several times.
Discard the solution.
4. Refill the calibration beaker $\frac{2}{3}$ full with **HI9828-0** calibration solution.
5. Slowly place the sensors in the solution and dislodge bubbles that may adhere to the sensors.
Screw the calibration beaker completely onto the probe body.
Some solution may overflow!

6. Wait a few minutes for the measurement to stabilize.

From the **Calibration** menu select **Quick Calibration** then press **Start**.

A three item calibration menu will appear.

“pH” will start to blink along with the “Not ready” message.

7. The “Ready” message will appear when the pH reading has stabilized.

Press **Confirm** to store the calibration point.

The “Storing” message and a check mark will appear in the box next to “pH” to indicate a successful calibration.

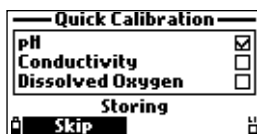
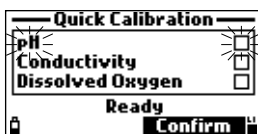
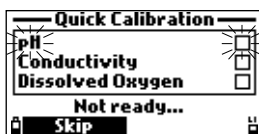

8. “Conductivity” will start to blink along with the “Not ready” message.

9. The “Ready” message will appear when the EC reading has stabilized.

Press **Confirm** to store the calibration point.

The “Storing” message and a check mark will appear in the box next to “Conductivity” to indicate a successful calibration.

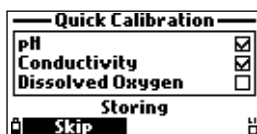
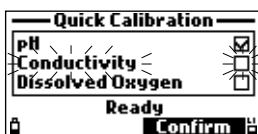
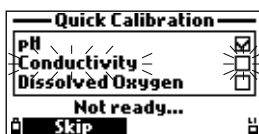

10. The message “Empty the beaker. Shake the probe and put it in the beaker again” will appear.
Unscrew the calibration beaker and discard the solution.

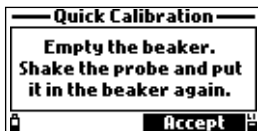

11. Shake any remaining solution off the probe. No droplets should remain on the DO sensor cap sensing surface.
Note: Do not wipe the sensing surface as damage may occur.
12. Shake any remaining solution out of the beaker. The calibration beaker should now be moist.
13. Slightly engage the calibration beaker onto the probe body.
Do not tighten the calibration beaker on the probe threads.
14. Wait at least 15 minutes for the air in the beaker to become saturated with water vapor.
15. Press **Accept**.
“Dissolved Oxygen” will start to blink along with the “Not ready” message.
16. The “Ready” message will appear when the DO reading has stabilized.
Press **Confirm** to store the calibration point.
The “Calibration complete” message and a check mark will appear in the box next to “Dissolved Oxygen” to indicate a successful calibration.

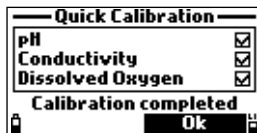
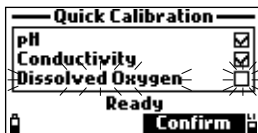
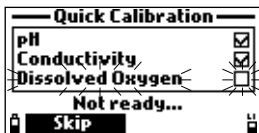

17. Press **Ok** to return to the calibration menu.
Note: To quit the quick calibration procedure, press **ESC** key at any time.

Error Message

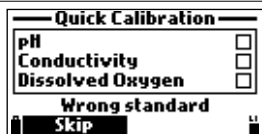

“Wrong standard” is displayed when the input is not within the acceptable range.

8.2. pH CALIBRATION

Calibration Options

Calibrate pH

The user can perform a new calibration using up to 3 buffers.

Option to select from pH 4.01, 6.86, 7.01, 9.18, 10.01; or use a custom buffer.

For a three-point calibration, new data overwrites existing calibration points.

With a single or two-point calibration the meter will also use information from the previous calibration, if available.

Restore Factory Calib.

The user should restore the factory calibration if a new pH sensor is installed.

Some messages displayed during calibration are based on previous calibration data.

A user calibration should follow immediately.

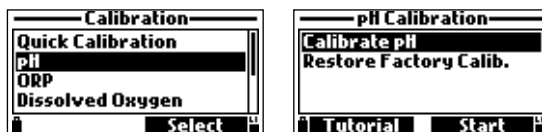

Procedure

Note: If the tutorial mode is enabled, press Tutorial and follow the messages on the screen.

1. Remove the shield from the probe and rinse the probe with purified water.
2. Fill the calibration beaker $\frac{2}{3}$ full with the first buffer solution.
3. Immerse the sensors in the buffer solution.
Raise and lower the probe several times.
Discard the solution.
4. Fill the calibration beaker $\frac{2}{3}$ full with the first buffer solution.
5. Slowly place the sensors in the selected buffer.
Dislodge bubbles that may adhere to the sensors.
6. Screw the calibration beaker completely onto the probe body.
Some solution may overflow!
7. Wait a few minutes for the measurement to stabilize.
8. Use the arrow keys to select **Calibrate pH** from the pH Calibration list.
9. Press **Start** to start the calibration.
The temperature, pH buffer value, and the "Not ready" message are displayed.
10. If necessary, press **Cal. point** to select the correct buffer.
11. To use a custom buffer, press **Custom**.
A text box window will appear. Use the keypad to enter the value of the buffer (0.00 to 14.00 pH) at the current temperature.

12. Press **Accept** to confirm the buffer value.

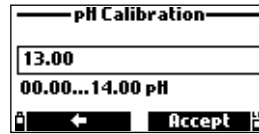
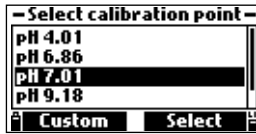

13. Once the reading has stabilized the countdown timer will count down until the display shows the "Ready" message.

Press **Confirm** to accept the calibration point.

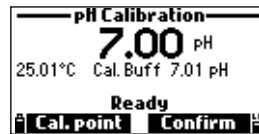

14. After the calibration point is confirmed, to avoid cross-contamination, empty and rinse the calibration beaker.
 15. Immerse the sensors in the next calibration buffer rinse solution and stir gently.
 16. Repeat the calibration procedure outlined above with the second and third buffers.

Note: To save a one or two-point calibration press the ESC key after the buffer is confirmed. The message "Storing" followed by "Calibration completed" will be displayed.

17. After the third buffer has been confirmed, the message "Storing" followed by "Calibration completed" will be displayed.
 18. Press **Ok** to return to the calibration menu or **Measure** to return to the measurement screen.



Error Messages

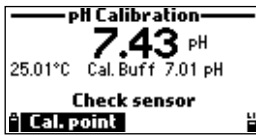

“Check sensor” is displayed when:

- the electrode is broken, very dirty, or the user has attempted to calibrate the same buffer value twice.
- an erroneous slope condition has been detected i.e. the slope difference between the current and previous calibration exceeds the slope window (80% to 110%).

Press **Clear** to cancel the old data and continue the calibration procedure, Alternatively, press **ESC** key to exit the pH calibration mode.

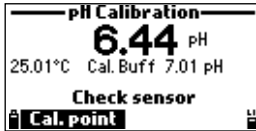

“Wrong buffer” is displayed when the pH reading is too far from the selected buffer value.

This is often seen immediately after a buffer calibration has been completed but before the pH sensor has been moved to the next buffer.

Check if the correct calibration buffer has been selected.

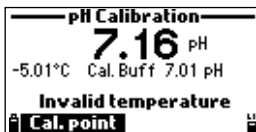

“Invalid temperature” is displayed when the buffer temperature is outside the acceptable range.



“Contaminated buffer” is displayed when the buffer is contaminated or the sensor is broken or very dirty.

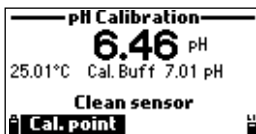

“Clean sensor” is displayed when the electrode is broken or very dirty.

8.3. ORP CALIBRATION

ORP calibration is used to compensate for changes in the potential due to contamination of the sensing surface and drift in the reference electrode.

Calibration is not typically required but it does establish a baseline that can be used for future validations.

Note: *ORP values are not temperature compensated and can change with temperature.*

ORP values should be reported with the reference electrode used and the temperature.

The HI7698194-1 reference is a Ag/AgCl reference with Cl-activity equivalent to 3.5M KCl.

Calibration Options

Custom ORP The user can perform a single point calibration using a custom point.

Restore Factory Calib. The user should restore the factory calibration if a new sensor has been installed.

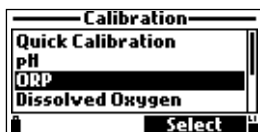

Procedure

Note: *If the tutorial mode is enabled, press Tutorial and follow the messages on the screen.*

1. Remove the shield from the probe and rinse the probe with purified water.
2. Fill the calibration beaker $\frac{2}{3}$ full with the ORP test solution for rinsing.
3. Immerse the sensors in the solution.
Raise and lower the probe several times.
Discard this solution.
4. Fill the calibration beaker $\frac{2}{3}$ full with the ORP test solution with a known ORP value.
5. Slowly place the sensors in the solution. Dislodge bubbles that may adhere to the sensors.
6. Screw the calibration beaker completely onto the probe body.
Some solution may overflow!
7. Wait a few minutes for the measurement to stabilize.
8. Use the arrow keys to select **Custom ORP**.
9. Press **Start** to start the calibration.
A text box window will appear. Use the keypad to enter the value of the solution at the current temperature.
10. Press **Accept** to confirm the calibration point.

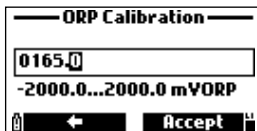

11. The stability counter will count down until the display shows the “Ready” message.



12. Press **Confirm** to accept the calibration point.

The message “Storing” followed by “Calibration completed” will be displayed.

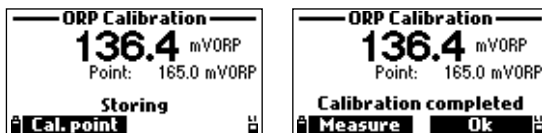

13. Press **Ok** to return to the calibration menu or **Measure** to return to the measurement screen.

Error Message



“Wrong standard” is displayed when the ORP input is not within the acceptable range.

8.4. DISSOLVED OXYGEN CALIBRATION

The accuracy of dissolved oxygen measurement is directly related to the sensing surface cleanliness and calibration technique. Oily coatings and biological contaminations are the primary cause of calibration drift.

A standard solution or a reference DO meter may be used to compare readings during calibration.

Calibration Options

% DO Saturation The user can perform a one or two-point calibration using 100 % and 0 % saturation or a one-point calibration using a custom solution (50 to 500 % saturation).

DO Concentration The user can perform a single point calibration using a custom point.

Restore Factory Calib. The user can restore the factory calibration if a new sensor has been installed.

Note: When the % DO range is calibrated, the DO concentration range is also calibrated, and vice versa.

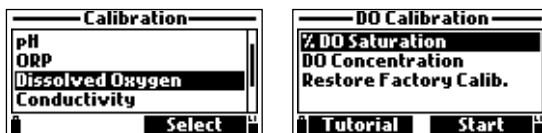

Note: If the tutorial mode is enabled, press Tutorial and follow the messages on the screen.

% DO Saturation Calibration

- Remove the shield from the probe and rinse the probe with purified water.
- Shake any remaining solution off the probe.

No droplets should remain on the DO sensor sensing surface.

Calibration at 100 % Saturation

Note: Do not calibrate the DO sensor in dry air!

1. To calibrate at 100 % saturation, place a moistened sponge in the bottom of the calibration beaker.
2. Place the calibration beaker on the probe body.
Do not tighten the calibration beaker on the probe threads!
3. Wait at least 15 minutes for the air to become saturated with water vapor.
This condition corresponds to 100 % air-saturated water at the temperature of measurement.
4. Press **Start** to start the calibration.
The reading, temperature, calibration point, and the “Not ready” message are displayed.
5. Once the reading has stabilized the countdown timer will count down until the “Ready” message is displayed.
Press **Confirm** to accept the calibration point.



Calibration at 0 % Saturation

1. Mix the **HI7040** bicomponent Zero oxygen solution.
2. Fill the calibration beaker $\frac{2}{3}$ full.
3. Slowly place the sensors in the solution.
Dislodge bubbles that may adhere to the sensors.
4. Screw the calibration beaker completely onto the probe body.
Some solution may overflow!
5. The stability timer will count down until the display shows the “Ready”.
Press **Confirm** to accept the calibration point.
The message “Storing” followed by “Calibration completed” will be displayed.
6. Press **Ok** to return to the calibration menu or **Measure** to return to the measurement screen.

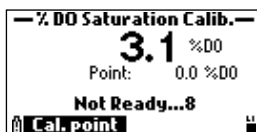

Notes: To save a one calibration press the ESC key after the standard is confirmed.

Single point Calibration at 100 %, 0 %, or Custom value

1. Calibrate at 100.0%
 - Select **Cal.point** then select 100.0%.
 - Follow steps 1–5 from **Calibration at 100% Saturation** section.
 - Press **Confirm** when “Ready” message appears.



2. Calibrate at 0.0%
 - Select **Cal.point** then select 0.0%.
 - Follow steps 1–6 from **Calibration at 0 % Saturation** section.
 - Press **Confirm** when “Ready” message appears.
3. Calibrate with Custom value
 - Place probe in the water sample needed for calibration.
 - Determine the value of the water sample independently.
 - Select **Cal.point** then select **Custom**.
 - A text box will appear.
Use the keypad to enter the % Saturated value.
 - Press **Accept**.

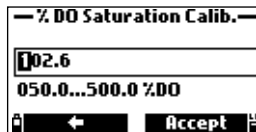

- The following messages will appear: “Storing” and “Calibration completed”.
- Press **Ok** to return to the “Calibration” menu.
- Press **ESC** twice to return to the main menu.
- Press **Measure** to return to the measurement screen.

DO Concentration Calibration

1. Remove the shield from the probe and rinse the probe with purified water.
2. Fill the calibration beaker $\frac{2}{3}$ full with the test solution.

Note: *The concentration of the solution should be determined independently.*

3. Immerse the sensors in the solution.
Raise and lower the probe several times then discard this solution.
Alternately, place probe directly in the water sample needed to calibrate in.
4. Refill the calibration beaker $\frac{2}{3}$ full with the test solution.
5. Slowly place the sensors in the solution.
Dislodge bubbles that may adhere to the sensors.

6. Only engage the calibration beaker one or two threads onto the probe body!
Some solution may overflow!
7. Wait a few minutes for the measurement to stabilize.
8. Use the arrow keys to select **DO Concentration** from DO Calibration list.
9. Press **Start** to start the calibration.
10. A text box window will appear.
Use the keypad to enter the value of the standard.
11. Press **Accept** to confirm.

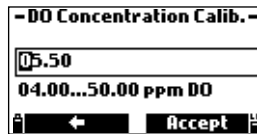

12. The stability timer will count down until the display shows the "Ready" message.

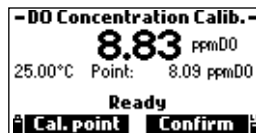

13. Press **Confirm** to accept the value.
The message "Storing" followed by "Calibration completed" will be displayed.

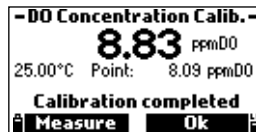

14. Press **OK** to return to the calibration menu or **Measure** to return to the measurement screen.

Error Messages



"Invalid temperature" is displayed when the temperature input is not within the acceptable range i.e. 0 to 50 °C.



"Wrong standard" is displayed when the DO input is not within the acceptable range.

8.5. CONDUCTIVITY CALIBRATION

Conductivity calibrations are used to correct for variations in cell factors.

Oily coatings and biological contaminations can cause changes in the cell geometry.

The EC electrodes are located inside two small channels on the bottom of the sensor. They can be cleaned with the small brush from the maintenance kit. A mild detergent can be used to remove oily coatings. Flush the electrodes with water thoroughly after cleaning.

Calibration Options

- Conductivity** The user can perform a one-point calibration using a standard solution. The calibration is temperature compensated.
Note: for best results select a conductivity standard closest to the water samples being measured.
- Absolute Conductivity** The user can perform a one-point calibration with a known conductivity solution that is not temperature compensated.
- Salinity** The user can perform a one-point calibration with a known salinity solution (PSU).
- Restore Factory Calib.** The user can restore the factory calibration if a new sensor has been installed.

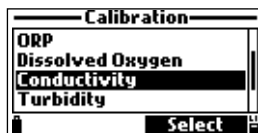

Note: The probe shield or calibration beaker must be used during calibration.

When the Conductivity is calibrated, also the Absolute Conductivity and Salinity is calibrated (and vice versa). A Conductivity calibration is recommended.

Note: If the tutorial mode is enabled, press Tutorial and follow the messages on the screen.

Conductivity Calibration

1. Remove the shield from the probe and rinse the probe with purified water.
2. Fill the calibration beaker $\frac{2}{3}$ full with the conductivity standard solution.
3. Immerse the sensors in the solution.
Raise and lower the probe several times then discard this solution.
4. Refill the calibration beaker $\frac{2}{3}$ full with the conductivity standard solution.
5. Slowly place the sensors in the solution.
Dislodge bubbles that may adhere to the sensors.
6. Screw the calibration beaker completely onto the probe body.
Some solution may overflow!

7. Use the arrow keys to select **Conductivity** from the Conductivity Calibration list.
8. Press **Start** to start the calibration.
9. If necessary, press **Cal. point** to select the correct standard.
10. To enter a user-defined standard, press **Custom**.
A text box window will appear.
Use the keypad to enter the value of the standard (100 to 200000 $\mu\text{S}/\text{cm}$) at the current temperature.
11. Press **Accept** to confirm the standard value.



12. Once the reading has stabilized, the stability timer will count down until the display shows the "Ready" message.



13. Press **Confirm** to save the calibration.
The message "Storing" followed by "Calibration completed" will be displayed.
14. Press **Ok** to return to the calibration menu or **Measure** to return to the measurement screen.

To Calibrate Offset

1. Remove the shield from the probe and rinse the probe with purified water.
2. Shake all water from the probe.
3. Use a tissue to dry off the EC sensor. There should be no moisture in or on the sensor.
4. Suspend the probe in the air (infinite resistance).
5. Press **Start** to initiate the calibration.
6. Press **Cal point** and use the arrow keys to choose 0 $\mu\text{S}/\text{cm}$.
7. Press **Select**.

Once the reading has stabilized, the stability timer will count down until the display shows the "Ready" message.

8. Press **Confirm**. "Calibration Complete" will be displayed.
9. Press **OK** to return to the calibration menu

Absolute Conductivity (EC) Calibration

1. Remove the shield from the probe and rinse the probe with purified water.
2. Fill the calibration beaker $\frac{2}{3}$ full with the test solution with known concentration.
3. Immerse the sensors in the solution. Raise and lower the probe several times then discard this solution.
4. Refill the calibration beaker $\frac{2}{3}$ full with the test solution with known concentration.
5. Slowly place the sensors in the solution. Dislodge bubbles that may adhere to the sensors.

6. Screw the calibration beaker completely onto the probe body.
Some solution may overflow!
7. Wait a few minutes for the measurement to stabilize.
Use the arrow keys to select **Absolute Conductivity** from the Conductivity Calibration list.
8. Press **Start** to start the calibration.
A text box window will appear.
Use the keypad to enter the value of the standard (100 to 200000 $\mu\text{S}/\text{cm}^{\circ}$) at the current temperature.
9. Press **Accept** to confirm the standard value.

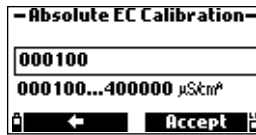

10. The stability counter will count down until the display shows the "Ready" message.



11. Press **Confirm** to save the calibration.
The message "Storing" followed by "Calibration completed" messages will be displayed.
12. Press **Ok** to return to the calibration menu or **Measure** to return to the measurement screen.

Salinity Calibration

The measurement of salinity is based on the Practical Salinity Scale which uses the EC measurement. If the user has a standard with known PSU value, it may be used to calibrate the conductivity sensor.

1. Remove the shield from the probe and rinse the probe with purified water.
2. Fill the calibration beaker $\frac{2}{3}$ full with salinity standard of a known value.
3. Immerse the sensors in the solution.
Raise and lower the probe several times then discard this solution.
4. Refill the calibration beaker $\frac{2}{3}$ full with the salinity standard.
5. Slowly place the sensors in the solution. Dislodge bubbles that may adhere to the sensors.
6. Screw the calibration beaker completely onto the probe body.
Some solution may overflow!
7. Wait a few minutes for the measurement to stabilize.
Use the arrow keys to select **Salinity** from the Conductivity Calibration list.
8. Press **Start** to start the calibration.
A text box window will appear.
Use the keypad to enter the value of the standard (5.00 to 70.00 PSU) at the current temperature.

9. Press **Accept** to confirm the standard value.

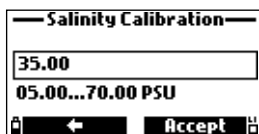

10. The stability counter will count down until the display shows the "Ready" message.

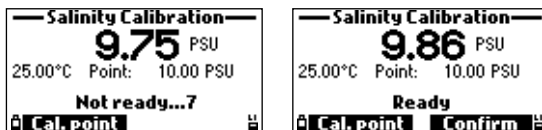

11. Press **Confirm** to save the calibration. The message "Storing" followed by "Calibration completed" will be displayed.
12. Press **Ok** to return to the calibration menu or **Measure** to return to the measurement screen.

Error Messages



"Invalid temperature" is displayed when the temperature input is not within the acceptable range (0 to 50 °C).



"Wrong standard" is displayed when the conductivity input is not within the acceptable range.

8.6. TURBIDITY CALIBRATION

The [HI7698594-4](#) sensor conforms to ISO 7027 standard.

For best results a three-point calibration (indoors) at 0.0 FNU, 20.0 FNU, and 200.0 FNU is recommended. Hanna Instruments® turbidity standards are STDVB polymer standards that have been specifically formulated for this sensor and meter. The STDVB polymer standards are available in ready-to-use concentrations to ensure accurate turbidity calibrations and measurements.

See [16. Accessories](#) for information regarding Hanna Instruments calibration solutions.

Note: *Turbidity standard formulations made with polystyrene beads are instrument-specific and cannot be substituted with standards made for another turbidity sensor.*

Calibration Options

Calibrate Turbidity The user can perform a new calibration in up to three calibration points (0.0, 20.0, 200.0 FNU).

Restore Factory Calib. Clears previous user calibration.

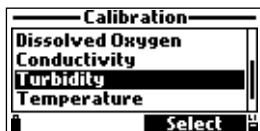

Verify the sensor is clean before calibrating.

Use the [HI7698293](#) calibration beaker for calibration. Calibrate indoors for best results.

Calibrate every time the sensor is replaced and as part of yearly validation routine.

Procedure

Note: *If the tutorial mode is enabled, press Tutorial and follow the messages on the screen.*

1. Remove the shield from the probe. Rinse the probe with purified water.
2. Pour quantities of selected standard solutions into clean beakers for rinse.
3. Fill the [HI7698293](#) calibration beaker 2/3 full with the zero standard.
4. Immerse the turbidity sensor into zero rinse beaker and then shake off excess solution.
5. Place the sensor into the calibration beaker. Dislodge bubbles that may adhere to the sensors.
6. Screw the calibration beaker completely onto the probe body.
Some solution may overflow!
7. Wait a few minutes for the measurement to stabilize.
8. Use the arrow keys to select **Calibrate turbidity** from the Turbidity Calibration list.
9. Press **Start** to start the calibration.

The turbidity standard value and the "Not ready" message are displayed.

10. Once the reading has stabilized, the display shows the “Ready” message.

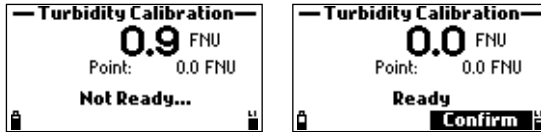

11. Press **Confirm** to accept the calibration point.
12. After the calibration point is confirmed, to avoid cross-contamination, immerse the sensors in the next calibration standard rinse solution and stir gently.
13. Repeat the calibration procedure outlined above with 20.0 FNU and 200.0 FNU standards.

Note: To save a one or two-point calibration, press the ESC key after the standard is confirmed. The message “Storing” followed by “Calibration completed” will be displayed.

A one-point calibration is only recommended to update the offset of a previous two or three-point calibration. A two-point calibration is only recommended when the expected turbidity readings are below 40.0 FNU.

14. After the third point has been confirmed, the message “Storing” followed by “Calibration completed” will be displayed.
15. Press **OK** to return to the calibration menu or **Measure** to return to the measurement screen.

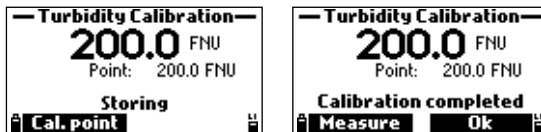

Error Messages



“Wrong standard” is displayed when the turbidity input is not within the acceptable range.

8.7. TEMPERATURE CALIBRATION

Calibration Options

- Calibrate Temperature** The user can perform a single point calibration.
Note: Temperature calibration should be made prior to sensor calibration.
- Restore Factory Calib.** Clears previous user calibration.

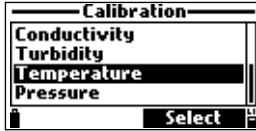

Procedure

Note: If the tutorial mode is enabled, press Tutorial and follow the messages on the screen.

1. Remove the shield from the probe. Rinse the probe with purified water.
2. Place the probe in an isothermal bath with a reference instrument.
3. Allow the probe to come to thermal equilibrium.
4. Use the arrow keys to select **Calibrate Temperature** from Temperature Calibration list.
5. Press **Start** to start the calibration.
6. A text box window will appear.
Use the keypad to enter the calibration temperature (-5 to 50 °C).
7. Press **Accept** to confirm the value.

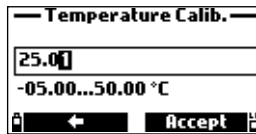

8. The stability timer will count down until the display shows the “Ready” message.

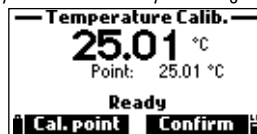

9. Press **Confirm** to store the calibration point. The message “Storing” followed by “Calibration completed” is displayed.



10. Press **OK** to return to the calibration menu or **Measure** to return to the measurement screen.

Error Message



“Wrong standard” is displayed when the temperature input is not within the acceptable range.

8.8. PRESSURE CALIBRATION

Calibration Options

- Custom Pressure** The user can perform a single point calibration.
Note: Pressure calibration should be made prior to DO sensor calibration.
- Restore Factory Calib.** Clears previous user calibration.

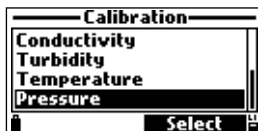

Procedure

Note: If the tutorial mode is enabled, press Tutorial and follow the messages on the screen.

1. Use a reference barometer to obtain the true local barometric pressure reading.
2. Use the arrow keys to select **Custom Pressure** from Pressure Calibration list.
3. Press **Start** to start the calibration.
4. A text box window will appear.
Use the keypad to enter the calibration pressure in units of psi (8.702 to 16.436 psi).
5. Press **Accept** to confirm the standard value.

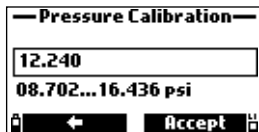

6. The stability counter will count down until the display shows the "Ready" message.
7. Press **Confirm** to store the calibration point.



8. After confirmation, the message "Storing" followed by "Calibration completed" will be displayed.



9. Press **OK** to return to the calibration menu or **Measure** to return to the measurement screen.

Error Message



"Wrong standard" is displayed when the atmospheric pressure input is not within the acceptable range.

9. MAINTENANCE

9.1. GENERAL MAINTENANCE

- Inspect all sensor connectors for corrosion. Replace sensors if necessary.
- Inspect sensor o-ring for nicks or other damage. Replace the o-ring if necessary.

 Use only the supplied grease as some lubricants can cause the o-ring to expand.

- After prolonged storage or cleaning, calibrate the sensor.
- After use rinse the probe with tap water and dry it.
- Keep the pH electrode bulb and DO sensor moist.

pH and pH/ORP Sensor

- Remove the sensor protective shield.
- If the bulb and/or junction are dry, soak the electrode in [HI70300](#) Storage solution for at least 30 minutes.
- To ensure a quick response time, the glass bulb and the junction should be kept moist and not allowed to dry. Store the sensor with a few drops of [HI70300](#) Storage solution or pH 4.01 buffer in the protective cap. Tap water may also be used for a very short period (few days).

 Never use distilled or deionized water to store pH sensors.

- Inspect the sensor for scratches or cracks. If any are present, replace the sensor.
- Rinse the sensor in flowing water then clean by soaking it for 1 minute in [HI70670](#) Cleaning solution for mineral deposits or [HI70671](#) Cleaning and disinfection solution for algae, fungi, and bacteria. After cleaning, soak the sensor in [HI70300](#) Storage solution for 30 minutes before calibrating.

DO Sensor

Cleaning the Smart Cap

- Use a mild detergent and a soft-bristled toothbrush (not the brush in the maintenance kit!) to clean.
- Rinse with water after cleaning and dry with a laboratory tissue.
- Hydrate in purified water before use.

Smart Caps require replacement on a yearly basis.

Note: *The first time a new DO Smart Cap is installed on a sensor and the sensor is installed in a probe and powered, the Cap start date will be registered in the Probe Status screen. After one year, a pop-up message will signal expiration.*

EC/Turbidity Sensor

Rinse the probe with tap water after measurements.

If a more thorough cleaning is required:

- Clean the sensor with brush to loosen any debris.
- Use a mild detergent to remove oily coatings.
- Ensure that the cylindrical holes in the sensor are free of foreign material.
- Flush with water after cleaning.

9.2. SENSOR MAINTENANCE

For correct sensor maintenance:

1. Unscrew to remove the protective shield from the probe body and set aside.
2. Use the calibration beaker for cleaning
3. Use [HI76984942](#) probe maintenance kit. See section [16. Accessories](#) for details.

Note: If the sensors are removed from the probe body, the body of the sensors must be dried prior to installation to prevent water from entering the sockets.

9.3. SENSOR REPLACEMENT

It is generally recommended to replace the sensors in the following order:

- EC/Turbidity sensor (7) » first
- pH/ORP sensor (5) » second
- opdo[®] sensor (3) » last

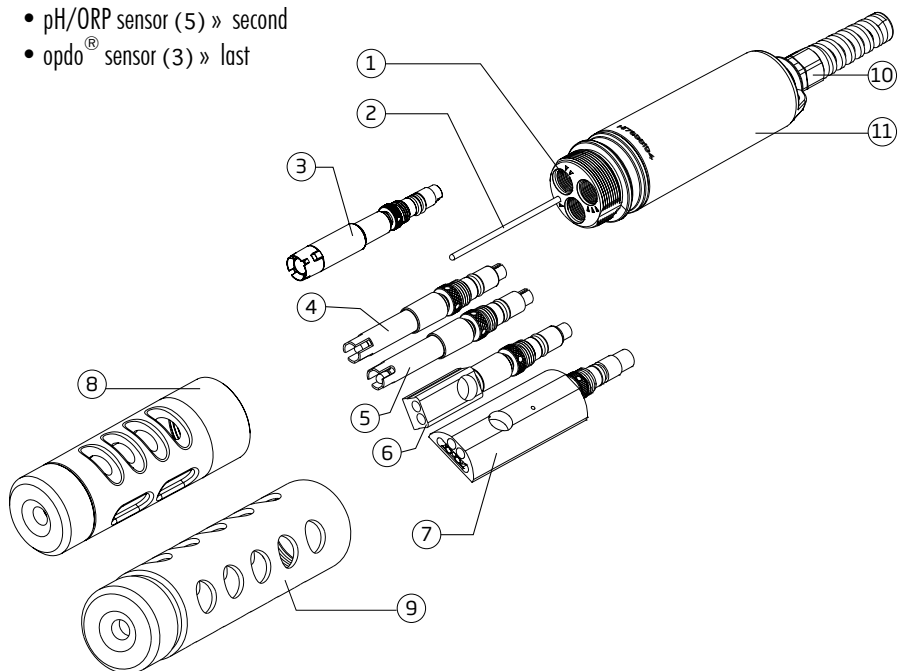

- | | |
|------------------------------|---|
| 1. Sensor sockets | 6. EC sensor |
| 2. Temperature sensor | 7. EC/Turbidity sensor |
| 3. opdo [®] sensor | 8. Short protective shield (ordered separately) |
| 4. pH sensor | 9. Long protective shield (supplied with the meter) |
| 5. pH/ORP combination sensor | 10. Strain relief |
| | 11. Probe body |

Note: To maintain a waterproof probe, if a sensor is not installed a plug must be inserted.

9.4. SENSOR TYPES & DESCRIPTIONS

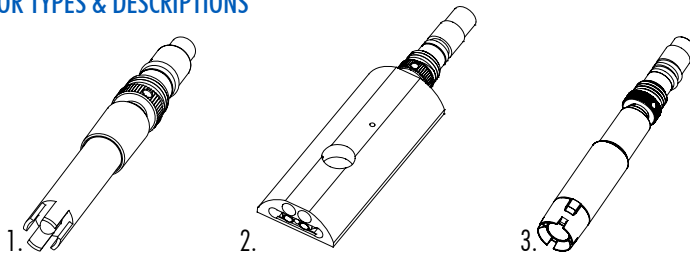

1. HI7698194-0 combination pH sensor

It features a PEI-body pH sensor with a glass bulb and a silver/silver chloride double junction reference with gelled electrolyte.

HI7698194-1 combination pH/ORP sensor

It features a PEI-body pH sensor with a glass bulb, a platinum sensor for redox measurements and a silver/silver chloride double junction reference with gelled KCl electrolyte.

2. HI7698594-4 combination EC/Turbidity sensor

It features a four-electrode conductivity sensor and a turbidity sensor that conforms to ISO 7027 standards.

3. HI7698594-5 optical dissolved oxygen (opdo[®]) sensor is based on the principle of fluorescence quenching. An immobilized Pt-based luminophore is excited by a blue LED light and emits a red light. As oxygen interacts with the luminophore it reduces the intensity and lifetime of the luminescence. The lifetime of the luminescence is measured by a photodetector and is used to calculate the dissolved oxygen concentration.

Smart Cap Description

Smart Caps contain pre-loaded calibration coefficients that are automatically transmitted to the probe. The Smart Cap saves data in a data storage tag. If caps are switched between sensors, calibration is required. If sensors are switched between probes, recalibration is required.

See section [6.2.1. Probe and Sensor Preparation](#) for Smart Cap installation procedure.

The Smart Cap is locked in place on the optical probe and includes the immobilized O₂-sensitive luminophore with rugged, insoluble, black, oxygen-permeable protective layer.

Over time, the sensor's optical components can age but are compensated for by using the reference signal to compensate the measuring path. As a result, the sensor provides accurate DO measurements over long periods of time without the need for frequent calibration.

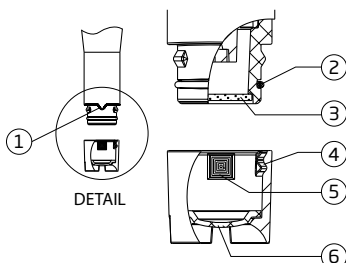

1 Alignment key

2 O-ring seal

3 Optical window

4 Smart Cap

5 Data storage tag

6 O₂ sensitive luminophore with black protective layer

9.5. SENSOR INSTALLATION

9.5.1. General Guidelines

To make installation easier, the probe has three sensor-connector sockets identified with color-coded triangles.

- ▼ connector 1 > [HI7698194-1](#) pH/ORP sensor or [HI7698194-0](#) pH sensor
- ▼▼ connector 2 > [HI7698594-5](#) Optical Dissolved Oxygen sensor
- ▼▼▼ connector 3 > [HI7698594-4](#) Conductivity and Turbidity sensor or [HI7698594-3](#) Conductivity sensor

It is generally recommended to install the sensors in the following order:

- opdo[®] sensor » first
- pH/ORP sensor » second
- EC/Turbidity sensor » last

To install the sensors follow the steps below:

1. Remove the protective shield from the probe and set aside.
2. Cut top off supplied sachet with silicone grease and sparingly lubricate the o-ring with a thin film of the grease. Do not substitute other grease or lubricants as it may cause the o-ring to swell!
3. Insert the sensor into the correctly color-coded opening while positioning the connector key toward the center of the probe.
Make sure the connector is seated correctly (the sensor will no longer move freely) before tightening the locking threads with your fingers.
4. Continue to tighten the locking thread with the small hex key supplied in the maintenance kit until the sensor is secured tightly against the probe body.
5. All sensors have to be conditioned and calibrated before use.
6. Screw the protective shield onto the probe body, to protect the sensors.

9.5.2. DO Sensor

DO Smart Cap replacement

Note: If a DO cap is expired, a pop-up message will occur at probe connection or when the meter starts with a connected probe. Pressing **Continue** button disables it temporarily or until the next connection.

1. Remove the [HI7698594-5](#) sensor from the probe before servicing the cap.
2. Remove the expired cap by squeezing the cap at the cutout arrow and then pull it off the sensor body. Do not twist!
3. Roll the used o-ring off the sensor.
4. Clean the o-ring groove and lens with a soft tissue followed by the lens cleaning wipe.
5. Remove the new o-ring from the replacement cap kit and slide on the sensor body.
Do not roll or twist the o-ring!

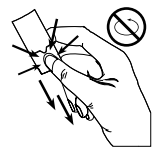

6. Remove the syringe plunger.
7. Cut the top off supplied sachet with silicone grease and empty contents into the syringe. Using the syringe, sparingly lubricate the o-ring with a thin film of the supplied grease. Avoid getting grease or fingerprints onto the optical window. Do not substitute other grease or lubricants as it may cause the o-ring to swell.
8. Remove the new optical cap from the replacement cap kit. Align the cutout arrow on the Smart Cap with the matching guide on the sensor body.
9. Slide and press the Smart Cap onto the sensor body until the cap snaps in place. Once the cap is installed, it should not be removed unless a new cap is required.
10. Place the sensor in a beaker of purified water to hydrate the Smart Cap before use.
11. Carefully reinstall the sensor in the probe.

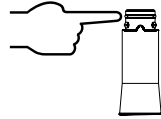

DO sensor installation

Prior to installing the DO sensor, identify the parting lines on the:

- probe body (A)
- sensor connector (B)
- sensor Smart Cap (C)

1. Align (A) and (B) parting lines.
2. Insert the sensor into the green-coded socket.
3. Push the sensor in taking care NOT to rotate the sensor!
4. Tighten the locking threads (D) with fingers.

Note: Rotating the sensor at this stage might damage the connector pins.

5. With the sensor seated and no longer moving freely, check (A) and (C) parting lines alignment.
6. If misaligned, repeat steps 1 and 2.
7. Continue to tighten the locking threads with the small hex key supplied.

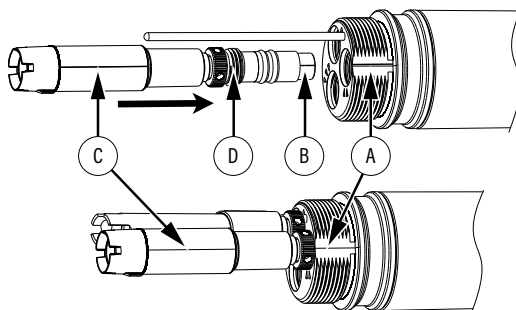

10. SYSTEM SETUP

- Press **Menu** from measurement screen.
- Use the arrow keys to highlight **System Setup** then press **Select**.
- Use the arrow keys to highlight the desired option then press **Select**.

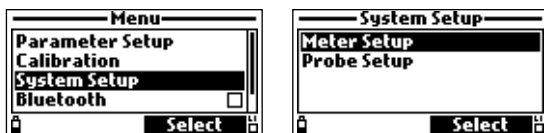

Note: When the password protection is enabled, authentication will be required before any modification.

10.1. METER SETUP

There are 14 items in the Meter Setup menu.

Pressing the corresponding numerical value brings the user directly to that item's position in the list.

- | | | |
|------------------|---------------------|-----------------------------|
| 1 Time | 6 Error Beep | 11 Meter ID |
| 2 Date | 7 Decimal Separator | 12 Language |
| 3 Auto Power Off | 8 LCD Contrast | 13 Delete paired devices |
| 4 Tutorial | 9 LCD Backlight | 14 Restore factory settings |
| 5 Key Beep | 10 Meter Password | |

Meter setup items with valid range and factory default settings

Setup Items	Options / Range	Default
Time	12 or 24 hours	24 hours current time
Date	DD/MM/YYYY, MM/DD/YYYY, YYYY/MM/DD, YYYY-MM-DD, MM-DD-YYYY, DD-MM-YYYY	YYYY/MM/DD current date
Auto Power Off	Disable 5, 10, 15, 20, 30, 60 minutes	Disable
Tutorial	Disable or Enable	Enable
Key Beep	Disable or Enable	Disable
Error Beep	Disable or Enable	Disable
Decimal Separator	Comma (,) or Period (.)	.
LCD Contrast	0 to 15	8
LCD Backlight	0 to 10	5
Meter Password	Disable or Enable	Disable
Meter ID	Up to 14 characters	—
Language	Deutsch, English, Español, Français, Magyar, Italiano, Lietuvių, Nederlands, Polski, Português, Română, Czech, Slovak	English
Delete paired devices	Yes or No	
Restore factory settings	Yes or No	

Time

Option: 12 or 24 hours

- Press **Modify** and set the time using the keypad.
- Press **Format** to change between 12 and 24 hours.
When the 12 hour format is used, use the down arrow to get to the ante or post meridian abbreviation. The first letter can be changed by pressing any key.
- Press **Accept** to save the option or press **ESC** key to return to the menu.

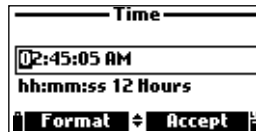
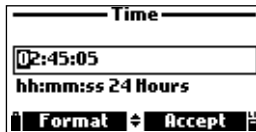

Date

Option: DD/MM/YYYY, MM/DD/YYYY, YYYY/MM/DD, YYYY-MM-DD, MM-DD-YYYY, DD-MM-YYYY

- Press **Modify** and set the date using the keypad.
- Press **Format** to change the date format.
- Press **Accept** to save or press **ESC** key to return to the menu.

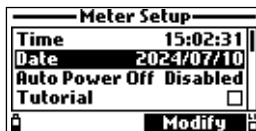

Auto Power Off

Option: Disabled, 5, 10, 15, 20, 30, 60 minutes

The function is used to save battery life.

After the set time has elapsed, the meter will:

- Automatically switch off, if in normal measurement mode.

Note: Press **On/Off** key to switch on again.

- Enter a sleeping mode, if the continuous logging mode is selected with a minimum logging interval of 30 seconds.

The "Power save mode" message and the **Wake up** functional key will be displayed on the LCD when it goes into this mode.

Logging is not stopped.

- Press **Wake up** to reactivate the display.

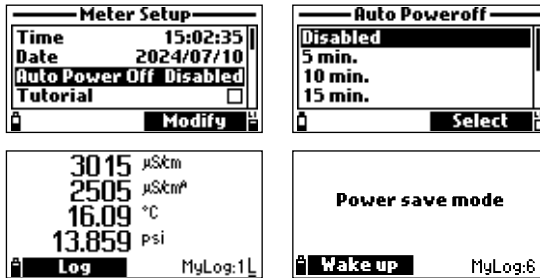

Tutorial

Option: Enabled or Disabled

When enabled, the user will be guided step-by-step through the sensor preparation, sensor maintenance, sensor installation and calibration procedures.



Key Beep

Option: Enabled or Disabled

When enabled, an acoustic signal is heard every time a key is pressed. Press the functional key to select the desired option.



Error Beep

Option: Enabled or Disabled

When enabled, a short beep is heard every time an incorrect key is pressed. A long beep alert sounds when the pressed key is not active or an error is detected. Press the functional key to select the desired option.

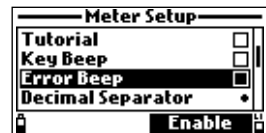

Decimal Separator

Option: Comma (,) or Period (.)

The user can select the type of decimal separator. Press the functional key to select the desired option.

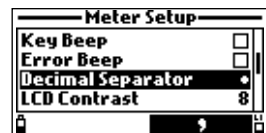

LCD Contrast

Option: 0 to 15

This function allows the adjustment of the LCD contrast.

- Press **Modify** and use the arrow keys to increase or decrease the contrast.

- Press **Accept** to save or press **ESC** key to return to the menu.

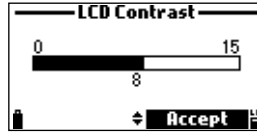
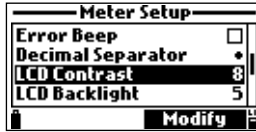

LCD Backlight

Option: 0 to 10

This function allows the adjustment of the LCD backlight intensity.

- Press **Modify** and use the arrow keys to change the backlight intensity.
- Press **Accept** to save or press **ESC** key return to the menu.

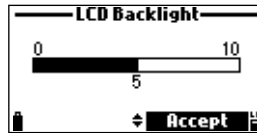

Meter Password

The meter password protects against unauthorized configuration changes and prevents log data from being deleted.

When implemented, certain settings and functions require authentication before modifying or viewing.

Once the password is entered, it will not be required until the meter is turned on again.

To enable the password:

1. Select **Meter Password** then press **Modify**.
2. Enter a 6 digit password in the text box.
3. Press **Accept**.

Note: While typing, the characters are masked with a "" (star) symbol.*

4. Reenter the password.
5. Press **Accept** to save or press **ESC** key to return to the menu.
6. The meter returns to the Meter Setup menu and the check mark indicates that the password protection has been enabled.



To disable the password protection:

1. Select **Meter Password** then press **Modify**.
2. Enter the password and then press **Disable**.
"No password" appears in the text box.
3. Press **Accept** to save or press **ESC** key to return to the menu.

Meter ID

Option: Up to 14 characters

- Press **Modify** to enter meter's ID setup screen.
- Use the keypad to set or change the meter's ID.
- Press **Accept** to save or press **ESC** key to return to the menu.

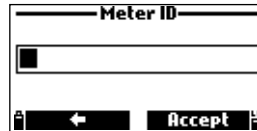

Language

Option: Czech, Deutsch, English, Español, Français, Magyar, Italiano, Lietuvių, Nederlands, Polski, Português, Română, Slovak

Option allows users to change meter's interface language.

- Press **Modify** and use the arrow keys to change the language.
- Press **Select** to save or press **ESC** key return to the menu.



Delete Paired Devices

This function removes all previous Bluetooth® connections.

- Press **Select** to delete all paired devices.
The meter will ask for confirmation.
- Press **Yes** to confirm or **No** to return to the menu.
“Previously paired devices removed” message will be displayed.

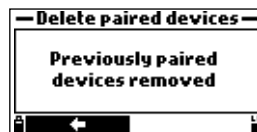
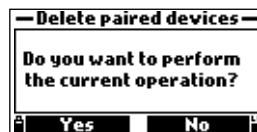

Restore Factory Settings

This function restores measurement settings to their original factory values. This includes measurement units, coefficients, other measurement configurations, and all logged data. The calibration for the sensor is not affected.

- Highlight **Restore factory** settings then press **Select**.
- Press **Yes** to confirm or press **No** to return to the menu.

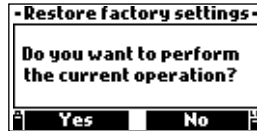

10.2. PROBE SETUP

Probe ID

Option: Up to 14 characters

- Press **Modify** to enter probe ID setup screen.
- Use the keypad to set or change the probe ID.
- Press **Accept** to save or press **ESC** key return to the menu.

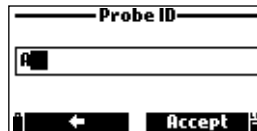
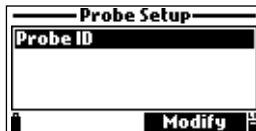

11. BLUETOOTH® 5.0

H198594 can be connected to the Hanna Lab App (version 3.0 or higher) using Bluetooth technology. The Hanna Lab App is available on the App Store® and on Google Play*; and features Hanna Cloud compatibility. See the Help section of the application for information on measurement, data logging, graphing, and data sharing.

Added features to the Hanna Lab App

- Logs can be shared as a .CSV or PDF file.
- GLP data can be viewed for all parameters when a log is downloaded to the iOS and Android device.
- Measurement units can be modified independently of the meter settings.
- Downloaded data is displayed in a table or a graph.

11.1. USING HANNA LAB APP

- Download and start the application on the smart device.
 - Grant required access.
 - Tap  symbol and the instrument's ID appears in the list of Available Devices.
 - Tap "Connect" to enable Bluetooth connectivity.
- All readings are transmitted directly to the application

11.2. PAIR A NEW DEVICE

1. Press **Menu** from the measurement screen.
2. Use the arrow keys to highlight "Bluetooth".
3. Press **Enable**.



4. When a device is paired with the meter for the first time, the meter will generate a 6-digit Bluetooth pin.

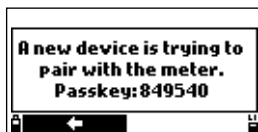

5. Enter the 6-digit pin to allow the pairing.
Once the devices are paired, the pin is not required when reconnected.
6. Press the arrow key to return to the previous screen.

* App Store is a trademark of Apple, Inc.
Google Play and the Google Play logo are trademarks of Google LLC.

11.3. DELETE PAIRED DEVICES

- Press **Select** option in **Meter Setup** to delete all paired devices.
After selecting this option, a prompt on display is asking for confirmation.

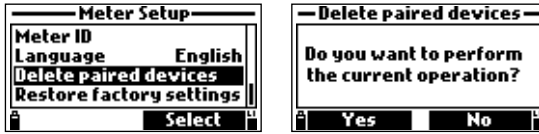

- Press **Yes** to confirm or **No** to return to the menu.
“Previously paired devices removed” message will be displayed.

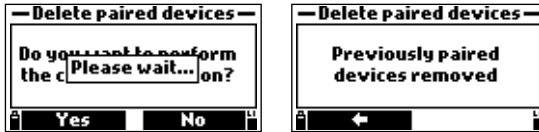

Note: A bonding pin will need to be re-entered when attempting a new Bluetooth connection.

11.4. FIRMWARE UPDATE

See the [Hanna Lab Help Section](#) for firmware update steps.

12. STATUS

- Press **Menu** from measurement screen.
- Use the arrow keys to highlight “Status” then press **Select**.
- Use the arrow keys to highlight the desired option then press **Select**.



12.1. METER STATUS

Meter Status displays information related to the batteries, charging status, logging, internal temperature, password, Meter ID, serial number and firmware version.



- Use the arrow keys to navigate through the meter status information.
- Press **ESC** key to return to the menu.

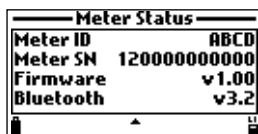
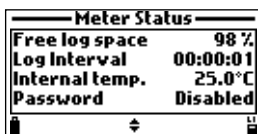
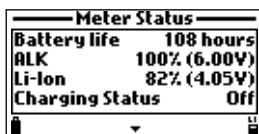

12.2. PROBE STATUS

Probe Status displays information related to the probe type, connected sensors, probe ID, serial number and firmware version.

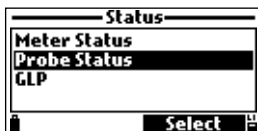

- Use the arrow keys to navigate through the probe status information.
- Press **ESC** key to return to the menu.

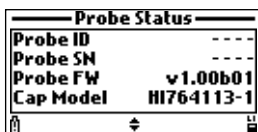
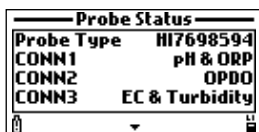

Note: The probe status screen will automatically be displayed when the probe sensor status has changed.

12.3. GLP

GLP (Good Laboratory Practice) is a set of functions that allows the user to store or recall data regarding the probe calibration. GLP data stores the last five calibrations.

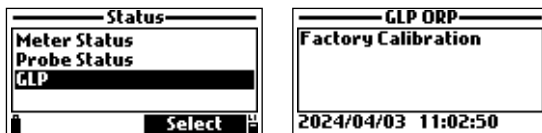

Note: If no user calibration data is available for the selected parameter, “Factory Calibration” message is displayed.

To navigate the GLP screens:

- Use the arrow keys to scroll through the stored data for the last 5 calibrations.
- Press ESC key to return to the menu.

pH

pH GLP screen displays: offset, acidic slope, basic slope, buffers used, time and date of the calibration.

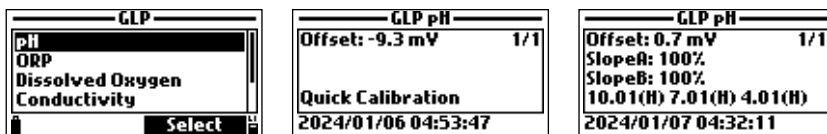

Note: A “C” label next to the buffer value indicates a custom point, while an “H” indicates a Hanna Instruments® standard buffer value.

If a quick calibration was performed, the buffer values are replaced with the “Quick Calibration”.

ORP

ORP GLP screen displays: calibration point, offset between measured and calibrated value, time, and date.

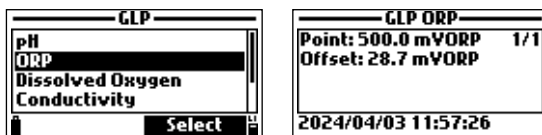

Dissolved Oxygen

DO GLP screen displays: calibration points, calibration type (% saturation or concentration), time and date.

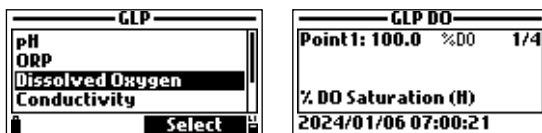

Note: A “C” label next to the calibration point indicates a custom point, while an “H” indicates a Hanna Instruments standard value.

If a quick calibration was performed, the calibration points are replaced with the “Quick Calibration”.

Conductivity

Conductivity GLP screen displays: calibration point, cell constant value, offset, calibration type (conductivity, absolute conductivity or salinity), time, and date.

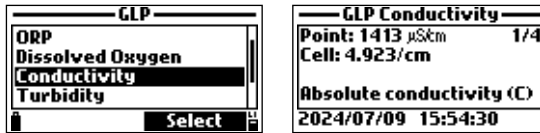

Note: A "C" label next to the calibration point indicates a custom point, while an "H" indicates a Hanna Instruments® standard value.

If a quick calibration was performed, the calibration point is replaced with the "Quick Calibration".

Turbidity

Turbidity GLP screen displays: factory calibration status, calibration time and date.

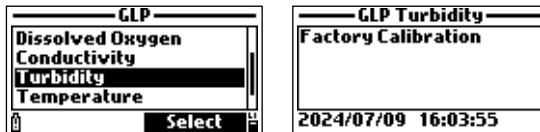

Temperature

Temperature GLP screen displays: calibrated point, time, and date.

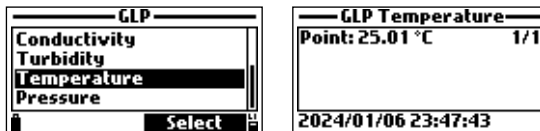

Pressure

Atmospheric pressure GLP screen displays: calibration point, time, and date.

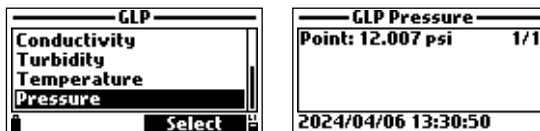

13. MEASUREMENT

During measurement mode HI98594 will simultaneously measure data for all enabled parameters.

Use the numbers 1 through 7 on the keypad to select the number of parameters that are shown on the screen at one time. The display will automatically resize the font.

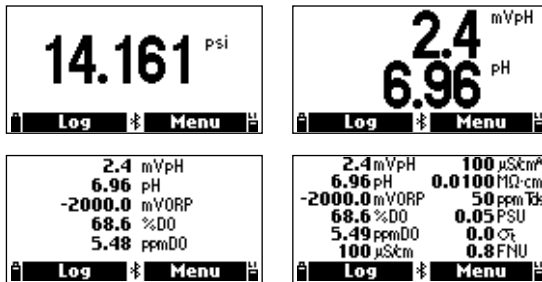

Use the arrow keys to scroll through the enabled parameters if they do not fit on one screen. A blinking measurement value indicates that the measurement is out of range.

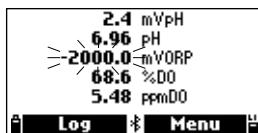

A blinking measurement unit indicates that the user calibration has not been done and is needed for accurate readings.

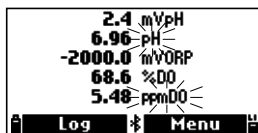

Measurement Guidelines

- Operate the probe with protective sleeve installed.
- To prevent the pH/ORP sensor from becoming electrically disconnected, do not position probe horizontally.
- Give the probe a firm shake to dislodge bubbles that may adhere and interfere with the measurements.
- Submerge the probe to ensure the conductivity probe and temperature sensor is in contact with representative sample.
- If measuring in a moving stream, position the probe at a 45° angle and position the sensor surfaces toward the flow.
- Avoid surface measurements in direct sunlight.

14. LOGGING

The HI98594 and the HI7698594 multisensor probe offer two types of logging: meter only parameters, and meter and probe parameters.

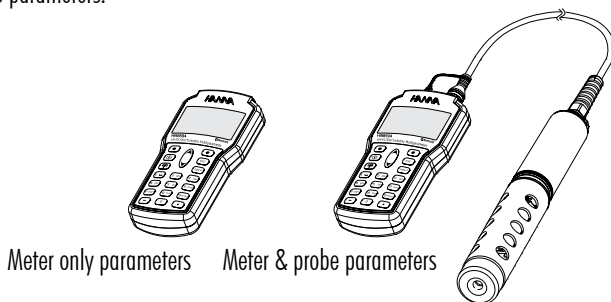

- From measurement mode, press **Log** to access Log menu.
- The data logged on the meter are organized by lots.
- Up to 50000 complete records can be stored in up to 100 lots.
- Each lot can store log-on-demand records or continuous records with different parameter configurations.

150.1 mVpH	0 μ S/cm ²
4.48 pH	1.0000 M Ω /cm
350.3 mVORP	0 ppm TDS
76.0 %DO	0.00 PSU
5.81 ppmDO	0.0 $^{\circ}$ C
0 μ S/cm	0.0 FNU
Log	Menu

Note: The values displayed for DO concentration, compensated conductivity, and TDS are dependent on the coefficients defined in Parameter Coefficients in Setup menu (EC Reference Temperature, EC Temperature Coefficient, TDS factor and Salinity).

If parameter units or coefficients are altered, stored logs will be altered, reflecting these changes.

Save logs to a PC before altering parameters or coefficients! Details are available for the enabled parameters only!

14.1. ONE SAMPLE ON METER

1. Select **One sample on meter** to add one set of enabled measurement parameters to the meter's memory.



2. If there are existing lots on the meter, select the lot to log the sample in.
3. If no lots have been saved or to create a new lot, press **New**. Use the keypad to enter desired lot name.
4. Press **Accept** to confirm.



5. Press **OK** to log the sample in the selected lot.
6. The Remarks window will open.
Press **Yes** to add a remark to the data point or **No** to skip.
7. The meter will return to the measurement screen automatically.



14.2. START METER LOG

1. Select **Start Meter Log** to log the enabled parameters at the set logging interval on the meter.



2. To set the logging interval, press **Options**.
The log interval time can be set from 1 second to 3 hours.
3. Press **Modify** and use the alphanumeric keys to enter the desired log interval.
4. Press **Accept** to confirm.

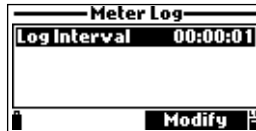

5. Press **Select** to start the logs.
Use the keypad to enter desired lot name.
6. Press **Accept** to confirm.
The Remarks window will open.
7. Press **Yes** to add a remark to the data point or **No** to skip.
The meter will return to the measurement screen and the log will start.
 - To stop the meter log, press **Log** then select "Stop Meter Log".
 - To update the remarks, press **Log** then select "Log Notes".

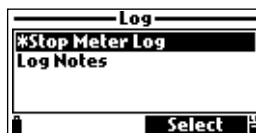

14.3. LOG RECALL

Select “Log Recall” to view logs that are stored on the meter.



14.3.1. Lots

Select this option to view all continuous log files saved on the meter.



1. Use the arrow keys to select the desired lot and then press **View**.
The meter displays a summary of all data related to the selected lot: number of samples, used memory space, time and date of the first and last readings.

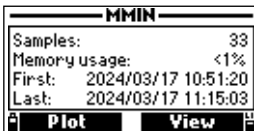

2. Press **View** to review the log data.
The sample number is shown on the bottom right corner of the display.
Use the arrow keys to change the sample number in the selected lot.
3. Press **Info** to see record information for the current sample: time and date, remark or serial number (if available).
4. Press **Data** to return to the previous screen or **Jump** to select a different sample in the same lot.
When **Jump** is pressed, a text box is displayed.
Use the keypad to insert the desired sample number.
5. Press **ESC** key to return to the menu.
6. Press **Plot**.
The meter creates a list with all available parameters that can be plotted.
7. Use the arrow keys to select the parameter to be plotted.
8. Press **Select** to view the graph.
Use the arrow keys to move the cursor in the graph and highlight a sample.
The sample data is displayed below the graph.
9. Press **ESC** key to return to the parameter list.

Note: To Export or Delete an individual Log, press **Options** (from the log list screen).

Export selected log data to USB-C Flash Drive:

1. Insert a USB-C flash drive (or USB-A with cable adapter) into the USB-C connector located on the top of the meter.
See section [14.5. PC Connection](#) for details.
2. Select **Export Log**.
“Connecting” will be displayed followed by the file transfer information.
When all files have been transferred, “File transfer completed.” message will be displayed.



14.3.2. Log On Demand

Select this option to view the log on demand lots and plot selected parameters.



1. Use the arrow keys to select the desired lot and then press **View**.
2. Press **View** to view the log data.



3. Press **Info** to see record information for the current sample: time and date, remark or serial number.

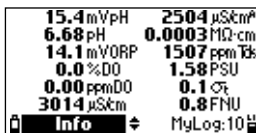

4. Press **Data** to return to the previous screen or **Jump** to select a different sample in the same lot.
When **Jump** is pressed, a text box is displayed.
Use the keypad to insert the desired sample number.

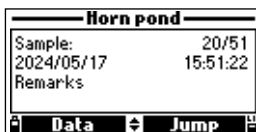

5. Press **ESC** key to return to the menu.

6. Press **Plot**. The meter creates a list with all available parameters that can be plotted.
7. Use the arrow keys to select the parameter to be plotted.
8. Press **Select** to view the graph.

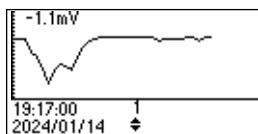

9. Use the arrow keys to move the cursor in the graph and highlight a sample.
The sample data is displayed below the graph.
10. Press **ESC** key to return to the parameter list.

Note: The number of lot samples that can be plotted is limited by the display resolution. To view a complete graph download data to PC.

14.3.3. Export All Logs

Select this option to export all logs to a PC.



Export all logged data to USB-C Flash Drive:

1. Insert a USB-C flash drive (or USB-A with cable adapter) into the USB-C connector located on the top of the meter.
See section [14.5. PC Connection](#) for details to transfer files to a PC directly.
2. Select **Export All Logs**.
“Connecting” will be displayed followed by the file transfer information.
When all files have been transferred, “File transfer completed” message will be displayed.

14.3.4. Delete All Logs

- Select **Delete All Logs** from the Meter log recall list.
- The instrument will ask for confirmation.
- Press **Yes** to delete or **No** to return to the previous screen.
- Press **ESC** key to return to the “Log Recall” menu.



14.4. LOG NOTES

14.4.1. Remarks

The meter can store up to 20 remarks. A remark can be associated with each sample.

To add a remark:

1. Select **Log Notes** from the Log menu then select **Remarks**.

The display shows a list of stored remarks.



2. Press **New** to create a new remark .

Use the keypad to enter the new remark in the text box.

3. Press **Delete** to delete the selected remark from the meter.

If the deleted remark is used in an existing lot, the information will be still available in the lot data.



14.4.2. Delete All Remarks

- Select **Delete all remarks** from the Log Notes menu.
- The instrument will ask for confirmation i.e. “Do you want to perform the current operation?”.
- Press **Yes** to delete or **No** to return to the previous screen.

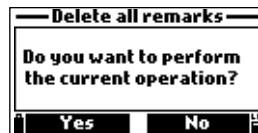
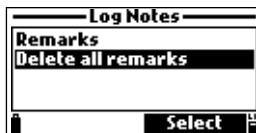

Note:

“!” displayed in log data indicates that the sensor/probe was used out of the operation parameters.

“!!” displayed in log data indicates broken or missing sensor.

14.5. PC CONNECTION

Probe and/or meter logged data can be transferred to a PC.

- Use the USB-A to USB-C cable to connect the meter to the PC.
- The meter will appear as a flash drive on the computer.
- Save files to the PC. All logs will be listed as .CSV files (comma separated values).

The .CSV files may be opened with any text editor or spreadsheet application.

All features of the spreadsheet program can be used to analyze and graph the data.

15. TROUBLESHOOTING & ERROR MESSAGES

HI98594 displays error messages to aid in troubleshooting.

Warnings are displayed for non-critical issues, while errors are displayed for critical issues.

See section [8. Calibration](#) for warning and error messages during calibration.



“Log space full” is displayed when the meter memory is full and additional data cannot be logged.

Delete one or more lots from the meter.

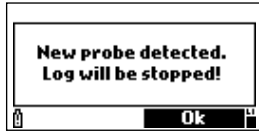

“New probe detected. Log will be stopped!” is displayed during interval log when the meter detects a different probe than the one with which the interval log was started.

Reconnecting the initial probe and not pressing OK will not stop the interval log.



“Flash drive over current detected.” is displayed when an unusually high current consumption is detected during log file export to an external flash drive.



“Language data not available!” is displayed when powering up the meter if the language file is not loaded.

Restart the meter.

If the problem persists, contact your local Hanna Instruments® office.

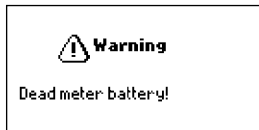

“Dead meter battery!” is displayed if the meter batteries are too low to power the meter. The meter will automatically turn off.

Connect the charger if using rechargeable battery or replace the alkaline batteries to continue.



“User data corrupted!” is displayed when powering up and the user data stored on meter are corrupted.

Restart the meter.

If the problem persists, contact your local Hanna Instruments office.



“Incompatible Probe! Remove Probe!” is displayed when the connected probe is not compatible with the meter.

Replace the probe.

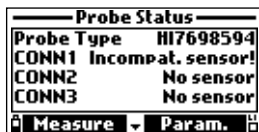

“Incompat.sensor!” is displayed in Probe Status screen when the connected sensor is not compatible with probe or meter.

Replace the sensor before continuing.

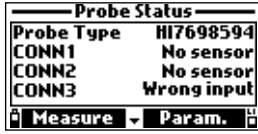

“Wrong input” is displayed in Probe Status screen when the connected sensor is not compatible with the connector.

Replace the sensor before continuing.

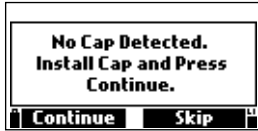

“No Cap Detected.” is displayed when the cap on the dissolved sensor is not inserted properly.

- Check and/or reseal the cap then press **Continue**.
- Press **Skip** to continue without the opdo[®] sensor.



“No Cap Info Detected.” is displayed during initialization when the cap information cannot be read.

- Check the cap, press **Continue**, and retry.
- Press **Skip** to continue without the opdo sensor.
- If the problem persists, replace the cap.

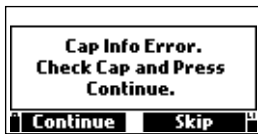

“Cap Info Error.” is displayed when the sensor is damaged.

- Reseat the cap and press **Continue**.
- Press **Skip** to continue without the opdo sensor.
- If the problem persists, replace the cap.



“Cap Expired.” is displayed when the cap has expired.

- Press **Continue** or replace the cap.

Continued use at this stage may result in incorrect measurements.
- Press **Skip** to continue without the opdo sensor.

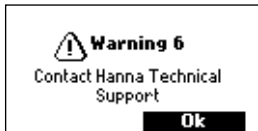

“Warning xxx”

Warnings displayed at power-on are identified using a numeric code. Some features can be accessed but with no guarantee.



- Restart the meter.
- If the problem persists, contact your local Hanna Instruments[®] office.

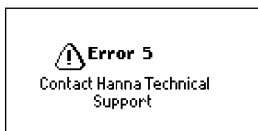

“Error x”

Critical errors are identified using a numeric code

- The meter switches off automatically.
- Contact your local Hanna Instruments office.

16. ACCESSORIES

Probes (supplied without sensors or protective shield)

Ordering Information	Product Description
HI7698594	Probe with 4 m (13.1') cable
HI7698594/10	Probe with 10 m (33.0') cable
HI7698594/20	Probe with 20 m (65.6') cable
HI7698594/40	Probe with 40 m (131.2') cable

Note: Probes with different cable lengths are available upon request.

Meters with Probes & Sensors

Ordering Information	Product Details
HI98594	HI98594 meter pH/ORP, EC/Turbidity, optical DO sensors probe with 4 m (13.1') cable
HI98594/10	HI98594 meter pH/ORP, EC/Turbidity, optical DO sensors probe with 10 m (33.0') cable
HI98594/20	HI98594 meter pH/ORP, EC/Turbidity, optical DO sensors probe with 20 m (65.6') cable
HI98594/30	HI98594 meter pH/ORP, EC/Turbidity, optical DO sensors probe with 30 m (98.4') cable
HI98594/40	HI98594 meter pH/ORP, EC/Turbidity, optical DO sensors probe with 40 m (131.2') cable
HI98594/50	HI98594 meter pH/ORP, EC/Turbidity, optical DO sensors probe with 50 m (164') cable

Sensors

Ordering Information	Product Description
HI7698194-0	pH sensor
HI7698194-1	pH/ORP sensor
HI7698594-3	EC sensor
HI7698594-4	EC/Turbidity sensor
HI7698594-5	Optical DO sensor
HI764113-1	DO Smart Cap with o-ring

Quick Calibration Solutions

Ordering Information	Product Description
HI9828-20	Quick calibration solution, 230 mL
HI9828-25	Quick calibration solution, 500 mL
HI9828-27	Quick calibration solution, 1 gallon (3.78 Liters)

pH Buffers

Ordering Information	Product Description
HI5004	pH 4.01 buffer solution, 500 mL
HI5068	pH 6.86 buffer solution, 500 mL
HI5007	pH 7.01 buffer solution, 500 mL
HI5091	pH 9.18 buffer solution, 500 mL
HI5010	pH 10.01 buffer solution, 500 mL

ORP Standards

Ordering Information	Product Description
HI7021L	ORP test solution, 240 mV @ 25 °C, 500 mL
HI7022L	ORP test solution, 470 mV @ 25 °C, 500 mL

pH / ORP Maintenance Solutions

Ordering Information	Product Description
HI70670L	pH/ORP cleaning solution for salt deposits, 500 mL
HI70671L	pH/ORP cleaning and disinfecting solution for algae, fungi and bacteria, 500 mL
HI70300L	pH/ORP electrode storage solution, 500 mL

DO Solutions

Ordering Information	Product Description
HI7040L	Zero oxygen solution set, 500 mL + 12 g

Conductivity Standard Solutions

Ordering Information	Product Description
HI7030L	12880 $\mu\text{S}/\text{cm}$ calibration solution, 500 mL
HI7031L	1413 $\mu\text{S}/\text{cm}$ calibration solution, 500 mL
HI7033L	84 $\mu\text{S}/\text{cm}$ calibration solution, 500 mL
HI7034L	80000 $\mu\text{S}/\text{cm}$ calibration solution, 500 mL
HI7035L	111800 $\mu\text{S}/\text{cm}$ calibration solution, 500 mL
HI7039L	5000 $\mu\text{S}/\text{cm}$ calibration solution, 500 mL

Turbidity Solutions

Ordering Information	Product Description
HI9829-16	0 FNU calibration solution, 230 mL
HI9829-17	20 FNU calibration solution, 230 mL
HI9829-18	200 FNU calibration solution, 230 mL

Other

Ordering Information	Product Description
HI7698290	Short calibration beaker
HI7698293	Long calibration beaker
HI7698295	Short protective shield
HI7698296	Long protective shield
HI7698297	Long, quick release flow cell
HI76984942	Probe maintenance kit with small brush, small hex key, o-rings for probe and grease to lubricate the o-rings, lens cleaning wipe
HI920016	USB type A to C cable
HI710034	Orange protective rubber boot for meter
HI710035	Blue protective rubber boot for meter
HI710036	Black protective rubber boot for meter

CERTIFICATION

All Hanna® instruments conform to the CE European Directives.



Disposal of Electrical & Electronic Equipment. The product should not be treated as household waste. Instead hand it over to the appropriate collection point for the recycling of electrical and electronic equipment which will conserve natural resources.

Disposal of waste batteries. This product contains batteries, do not dispose of them with other household waste. Hand them over to the appropriate collection point for recycling.

Ensuring proper product and battery disposal prevents potential negative consequences for the environment and human health. For more information, contact your city, your local household waste disposal service, or the place of purchase.

RECOMMENDATIONS FOR USERS

Before using this product, make sure it is entirely suitable for your specific application and for the environment in which it is used. Any variation introduced by the user to the supplied equipment may degrade the meter's performance. For your and the meter's safety do not use or store the meter in hazardous environments.

WARRANTY









The HI98594 is warranted for two years (sensors and probe for six months) against defects in workmanship and materials when used for its intended purpose and maintained according to instructions. This warranty is limited to repair or replacement free of charge. Damage due to accidents, misuse, tampering, or lack of prescribed maintenance is not covered.

If service is required, contact your local Hanna Instruments® office. If under warranty, report the model number, date of purchase, serial number (engraved on the bottom of the meter), and the nature of the problem. If the repair is not covered by the warranty, you will be notified of the charges incurred. If the instrument is to be returned to Hanna Instruments, first obtain a Returned Goods Authorization (RGA) number from the Technical Service department and then send it with shipping costs prepaid. When shipping any instrument, make sure it is properly packed for complete protection.

REGULATORY NOTICES

Stand-alone, Bluetooth[®], low-energy modules

All modules have identical operation. All references to US FCC Rules and Canadian RSS standards on device classification and operation, listed here under BMD-300 Module, apply to all models noted here. Remove the battery cover to check the installed module.

BMD-300 Module	
United States (FCC) FCC ID: 2AA9B04 This device complies with FCC Rules, Part 15, Subpart C “Intentional Radiators” and Subpart B, Chapter §15.105. This equipment has been tested and found to comply with the limits for a Class A digital device, pursuant to part 15 of the FCC Rules. These limits are designed to provide reasonable protection against harmful interference when the equipment is operated in a commercial environment. This equipment generates, uses, and can radiate radio frequency energy and, if not installed and used in accordance with the instruction manual, may cause harmful interference to radio communications. Operation of this equipment in a residential area is likely to cause harmful interference in which case, users are required to correct the interference at their own expense.	
Canada (ISED) IC: 12208A-04 This device complies with Industry Canada license exempt RSS standard(s). Operation is subject to the following two conditions: (1) this device may not cause interference, and (2) this device must accept any interference, including interference that may cause undesired operation of the device. Le présent appareil est conforme aux CNR d’Industrie Canada applicables aux appareils radio exempts de licence. L’exploitation est autorisée aux deux conditions suivantes: (1) l’appareil ne doit pas produire de brouillage, et (2) l’utilisateur de l’appareil doit accepter tout brouillage radioélectrique subi, même si le brouillage est susceptible d’en compromettre le fonctionnement.	
Australia / New Zealand (RCM) BMD-300 complies with the AS/NZS 4268:2017.	
Japan (MIC)  R210-106799	South Korea (KCC)  R-CRM-Rgd-BMD-300
Brazil (ANATEL): Contains ANATEL approved module # 00820-21-05903.	Mexico (IFETEL): Este equipo contiene el módulo con IFT #: NYCE/CT/0146/17/TS.
BMD-350 Module	
United States (FCC) FCC ID: 2AA9B05	Canada (ISED) IC: 12208A-05
Eurasia (EAC)  EA AC N RU U-S. HA27.B.00650/18	
Japan (MIC)  R210-108944	Australia / New Zealand (RCM) BMD-350 complies with the AS/NZS 4268:2017
South Korea (KCC)  R-C-Rgd-BMD-350	Brazil (ANATEL) Contains ANATEL approved module # 00857-21-05903
China (SRRC) CMIIT ID: 2018DJ7255	Mexico (IFETEL) Este equipo contiene el módulo con IFT #: RCPRI818-1491
ANNA-B112 Module	
United States (FCC) FCC ID: XPYANNAB1	Canada (ISED) IC: 8595A-ANNAB1
Taiwan (NCC) <small>Contains Transmitter Module</small> 內含發射器模組:  CCAI18LP2200T2	South Korea (KCC)  R-C-ULX-ANNA-B12
South Africa (ICASA) ICASA TA-2019/1203 Approved	China (SRRC) CMIIT ID: 2021DJ6698
Australia / New Zealand (ACMA) ANNA-B1 complies with AS/NZS 4268:2012 standard	
Japan (MIC)  R204-810005	The module complies with the Japanese Technical Regulation Conformity Certification of Specified Radio Equipment (ordinance of MPT No. 37, 1981), Article 2, Paragraph 1, Item 19 “2.4 GHz band wide band low power data communication system”.
 Brazil (ANATEL)	This equipment operates on a secondary basis and, consequently, must accept harmful interference, including from stations of the same kind, and may not cause harmful interference to systems operating on a primary basis.